

# WRT - Wireless Rotary Transducer

## Product Instructions

**Model**

4 Nm  
10 Nm  
20 Nm  
25 Nm  
75 Nm  
180 Nm  
500 Nm

**Part number**

6152210510  
6152210520  
6152210530  
6152210540  
6152210550  
6152210560  
6152210570



Download the latest version of this document at <https://www.desouttertools.com/>



**⚠ WARNING**

**Read all safety warnings and instructions**

Failure to follow the safety warnings and instructions may result in electric shock, fire and/or serious injury.

**Save all warnings and instructions for future reference**

# Table of Contents

<b>Product Information</b> .....	<b>4</b>
General Information.....	4
Website .....	4
Information about spare parts .....	4
Revision history.....	4
Overview .....	4
General description .....	4
Product Description.....	4
Dimensions .....	5
Weight.....	6
Battery.....	6
WLAN.....	6
Exposed network interfaces and services at factory default state .....	7
Technical Information.....	7
Regulatory Domain .....	8
Storage and Use Conditions .....	9
Accessories.....	9
User interface.....	9
LED system.....	10
USB port.....	11
<b>Installation</b> .....	<b>12</b>
Installation Instructions.....	12
How to install the battery.....	12
How to remove the battery .....	12
How to charge the battery .....	12
How to turn on/off the WRT.....	14
How to install the anti rotation holder .....	14
How to connect the WRT to the Web User Interface .....	14
How to log into the Web User Interface .....	15
How to log out of the Web User Interface .....	15
User roles and permissions.....	15
Initial Configuration.....	19
Web User Interface icons and buttons .....	19
How to configure the WRT using the Virtual Assistant.....	19
How to upgrade the application firmware.....	20
How to upgrade the Wi-Fi module firmware.....	21
Access Control.....	21
Open Protocol Server.....	25
<b>Operation</b> .....	<b>27</b>
Configuration Instructions.....	27
How to configure the WRT .....	27
How to configure demo Tests .....	31
How to configure tools.....	34
How to configure operations .....	35

Operating Instructions .....	39
How to run a demo test.....	39
How to run an operation.....	40
How to navigate Live Results.....	40
How to calibrate a tool with the Manual Adjustment .....	48
How to navigate Results Database .....	49
References .....	51
Operation types.....	51
Test types.....	59
Statistics types .....	63
<b>Service.....</b>	<b>67</b>
Diagnostic.....	67
How to run a diagnostic.....	67
How to download a diagnostic report.....	68
How to print a diagnostic report .....	68
How to check alarms status .....	68
Maintenance.....	68
How to save results locally.....	68
How to delete all tool and operations stored in the device.....	68
How to delete all curves and results stored in the device .....	68
How to reset the device to factory settings .....	69
How to enable/disable the Ethernet over USB connection .....	69
How to enable/disable the Web User Interface Virtual Assistant.....	69
How to enable/disable Log Files .....	69
How to select Log levels .....	69
How to download Log files .....	69
How to print Log Files .....	70
How to refresh Log file data .....	70
How to delete Log Files.....	70
Maintenance Instructions .....	70
Preventing ESD Problems .....	70
Preventive Maintenance.....	70
<b>Recycling.....</b>	<b>72</b>
Environmental Regulations .....	72
Recycling information .....	72

# Product Information

## General Information

### **⚠️ WARNING Risk of Property Damage or Severe Injury**

Ensure that you read, understand and follow all instructions before operating the tool. Failure to follow all the instructions may result in electric shock, fire, property damage and/or severe bodily injury.

- ▶ Read all Safety Information delivered together with the different parts of the system.
- ▶ Read all Product Instructions for installation, operation and maintenance of the different parts of the system.
- ▶ Read all locally legislated safety regulations regarding the system and parts thereof.
- ▶ Save all Safety Information and instructions for future reference.

## Website

Information concerning our Products, Accessories, Spare Parts, and Published Matters can be found on the Desoutter website.

Please visit: [www.desouttertools.com](http://www.desouttertools.com).

## Information about spare parts

Exploded views and spare parts lists are available in Service Link at <https://www.desouttertools.com/resource-centre>.

## Revision history

Firmware Release number	Revision date	Revision description
01.01x	02-2024	First issue.
04.00x	04-2025	Rev. 03
04.00x	06-2025	Rev. 04

## Overview

### General description

The WRT is a device designed for optimal operations in tool testing. It offers a set of test strategies for evaluating click-wrenches, slip-wrenches, nutrunners and pulse tools, measuring the torque and angle values and producing results with statistical parameters. The device consists of a rotary transducer with an integrated data collector system that communicates over a wireless network with a Web User Interface, which allows the user to configure the WRT, to manage testing operations and to get access to test results.

**i** When testing pulse tools, do not exceed 50% of the nominal torque of the WRT in use.

## Product Description

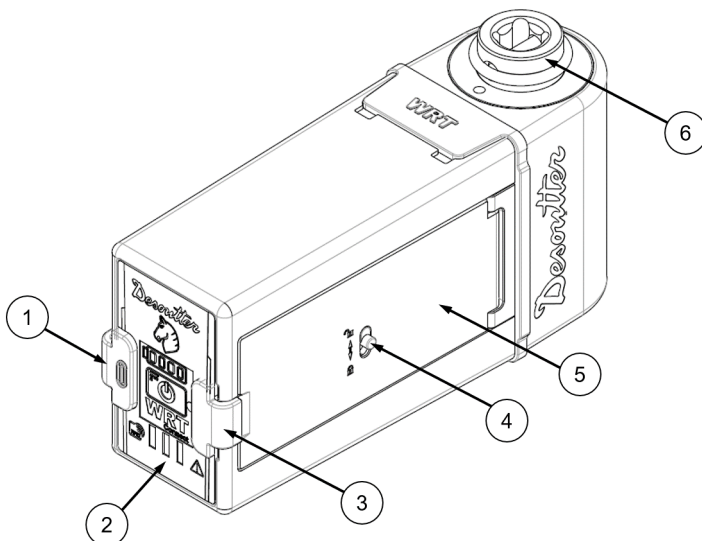

- 1 USB port cover
- 2 User interface
- 3 Battery cover clasp
- 4 Battery cover lock lever
- 5 Battery cover
- 6 Transducer

**Dimensions**

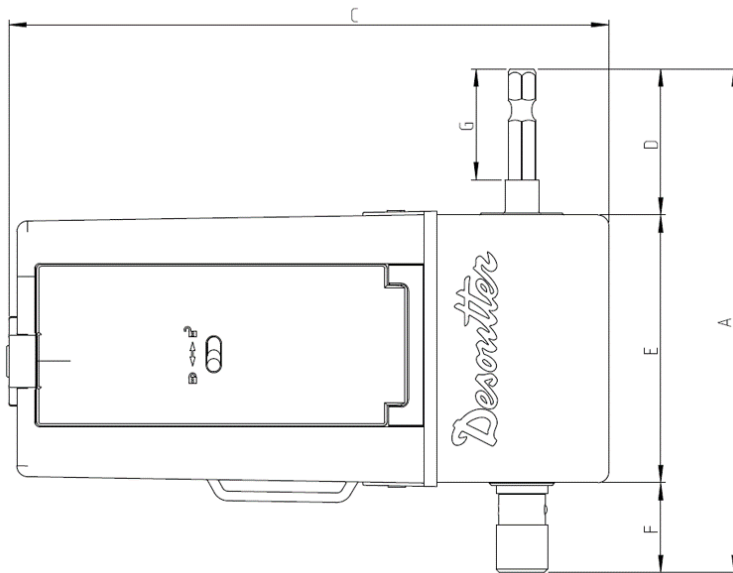

Illustration 1: Capacity 4 Nm, 10 Nm, 20 Nm

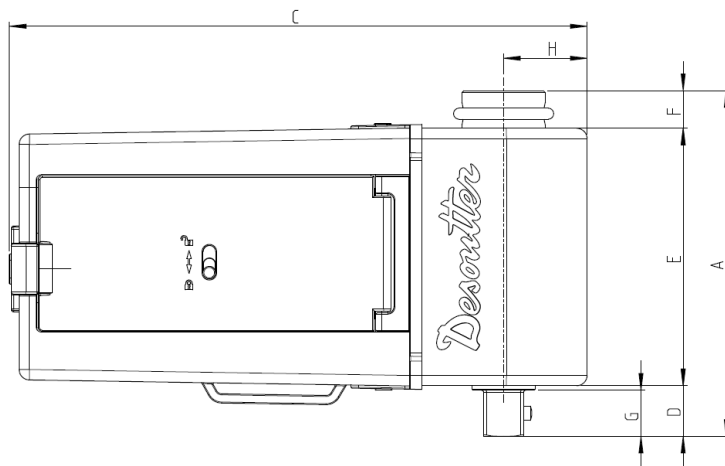

Illustration 2: Capacity 25 Nm, 75 Nm, 180 Nm

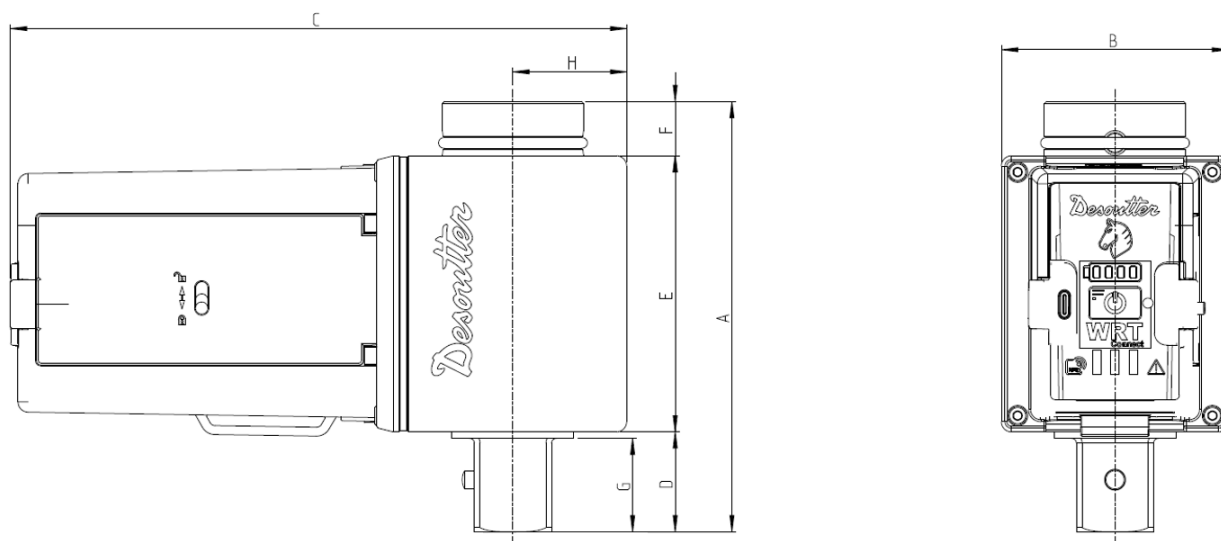

Illustration 3: Capacity 500 Nm

Capacity	Reference	Drive	A [mm]	B [mm]	C [mm]	D [mm]	E [mm]	F [mm]	G [mm]	H [mm]
4 Nm	6152210510	1/4" Hexagonal	115.8	45	138.3	33.8	61.5	20.5	25.5	20
10 Nm	6152210520	1/4" Hexagonal	115.8	45	138.3	33.8	61.5	20.5	25.5	20
20 Nm	6152210530	1/4" Hexagonal	115.8	45	138.3	33.8	61.5	20.5	25.5	20
25 Nm	6152210540	3/8" Square	82.6	45	138.3	12.1	61.5	9	11	20
75 Nm	6152210550	3/8" Square	82.6	45	138.3	12.1	61.5	9	11	20
180 Nm	6152210560	1/2" Square	90.5	45	141.8	17	61.5	12	15.2	22.5
500 Nm	6152210570	3/4" Square	106	56	151.9	24.6	68	13.4	23	28

### Weight

Capacity	Reference	Weight [gr]	Weight [lb]
4 Nm	6152210510	483.5	1.065
10 Nm	6152210520	484.7	1.068
20 Nm	6152210530	463.2	1.02
25 Nm	6152210540	486.4	1.07
75 Nm	6152210550	491.4	1.08
180 Nm	6152210560	599.7	1.32
500 Nm	6152210570	1094	2.41

### Battery

The WRT is powered by a rechargeable Li-ion battery (Model name: PA-L2431, P/N: 6159365310).

- Battery power supply: Rechargeable battery, Li-ion 3.635 VDC, 3.4 Ah
- Full charging time: Max. 5 hours
- Battery life (tested at 6 tightenings per minute): 8 hours

**i** Use the WRT battery pack (P/N: 6159365310) **only**.

### WLAN

- Type: IEEE 802.11b/g/n HT20; IEEE 802.11n HT40
- Frequency:
  - 2412 MHz ÷ 2484 MHz
  - 4900 ÷ 5975 MHz

- Maximum conduct output power:
  - 18 dBm
  - 13.5 dBm
- Maximum radiated output power:
  - IEEE 802.11b mode: 18.00 dBm
  - IEEE 802.11g mode: 18.43 dBm
  - IEEE 802.11n HT20 mode: 18.58 dBm
  - IEEE 802.11n HT40 mode: 16.75 dBm
- Receiver conducted sensitivity:
  - as low as -96 dBm
  - as low as -89 dBm

## Exposed network interfaces and services at factory default state

### Network Interface

Interface	Type	Description
Wi-Fi	Wi-Fi	Used for communication with clients on the network infrastructure.
USB (RNDIS mode)	Ethernet over USB	Used for point to point communication with clients.

### Exposed services

Service Name	Type	Ports	Description
Web User Interface	HTTPS	443	Used for communication with clients.
Production calibration	TCP (proprietary protocol)	81	Used for factory calibration only.
DHCP server	UDP	67	Used for assigning IP address to connected client.

## Technical Information

- Bridge Resistance: 1 k $\Omega$
- Output Sensitivity: 2mV/V
- Static accuracy:
  - Operating torque measuring range from 10 % to 100 % of the capacity
  - Maximum torque accuracy error (related to the value read by the transducer):  $\pm 0.50$  %
- Stability of zero offset with temperature:  $\pm 0.1\%$  of FSD/ $^{\circ}\text{C}$
- Torque overload capacity: 20% of FSD
- Maximum angular speed: 10.000 RPM.
- Resolution in degrees:

Capacity	Reference	Resolution in degrees
4 Nm	6152210510	0.0625 $^{\circ}$
10 Nm	6152210520	0.0625 $^{\circ}$
20 Nm	6152210530	0.0625 $^{\circ}$
25 Nm	6152210540	0.0625 $^{\circ}$
75 Nm	6152210550	0.0625 $^{\circ}$
180 Nm	6152210560	0.05625 $^{\circ}$
500 Nm	6152210570	0.0439453125 $^{\circ}$

- Results memory capacity: 50000 results, 5000 curves
- Unit of measurement supported: Nm, kg/m, kg/cm, lb/ft, lb/in, oz/ft, oz/in, kPm, dNm

## Product Information

### Maximum torque

Capacity	Reference	Maximum Torque	
4 Nm	6152210510	4 Nm	3.6 ft lb
10 Nm	6152210520	10 Nm	8.8 ft lb
20 Nm	6152210530	20 Nm	14.7 ft lb
25 Nm	6152210540	25 Nm	18.4 ft lb
75 Nm	6152210550	75 Nm	55.3 ft lb
180 Nm	6152210560	180 Nm	132.7 ft lb
500 Nm	6152210570	500 Nm	368.7 ft lb

### Regulatory Domain

A WLAN regulatory domain can be defined as a bounded area that is controlled by a set of laws or policies. Many countries follow standards set by FCC, ETSI, or worldwide

#### 2.4 GHz authorized channel list per regulatory domain

Channel	FCC America	ETSI		
		Europe	Worldwide	SRRC
1	x	x	x	x
2	x	x	x	x
3	x	x	x	x
4	x	x	x	x
5	x	x	x	x
6	x	x	x	x
7	x	x	x	x
8	x	x	x	x
9	x	x	x	x
10	x	x	x	x
11	x	x	x	x
12	N/A	x	N/A	x
13	N/A	x	N/A	x

#### 5 GHz authorized channel list per regulatory domain

Channel	Radio Band	FCC North	ETSI		Worldwide
		America	Europe	SRRC	
36	U-NII-1	x	x	x	x
40		x	x	x	x
44		x	x	x	x
48		x	x	x	x
52	U-NII-2	x	x	x	x
56		x	x	x	x
60		x	x	x	x
64		x	x	x	x
100	U-NII-2e	x	x	NA	x
104		x	x	NA	x
108		x	x	NA	x
112		x	x	NA	x
116		x	x	NA	x
132		x	x	NA	x
136		x	x	NA	x
140		x	x	NA	x

Channel	Radio Band	FCC North America	ETSI Europe	SRRC	Worldwide
149	U-NII-3	x	NA	x	x
153		x	NA	x	x
157		x	NA	x	x
161		x	NA	x	x
165		x	NA	x	x

### Storage and Use Conditions

- Indoor use only
- Altitude: Up to 2000m
- Ambient Temperature: 5 to 40°C
- Maximum relative humidity: Maximum relative humidity 80 % for temperatures up to 31°C decreasing linearly to 50 % relative humidity at 40°C
- Pollution Degree: 2
- IP Grade according to IEC/EN 60529: IP40 (only when USB protective cap is closed)
- Operation to reduced specification over a temperature range of -10 °C to 60 °C (the battery must not be recharged when operating in this range)
- Battery operating temperature: from -20 °C to +60 °C

### Accessories

#### WRT accessories

Name	Part number
WRT battery pack (Model name: PA-L2431)	6159365310
QA-CHARGER	6159364610
WRT 2x Adapters	6159365340
WRT anti-rotation holder	6159365350

**i** Use the Desoutter battery pack (P/N: 6159365310) **only**.

### User interface

The WRT User Interface consists of one physical ON/OFF button and of a LED system that communicates to the user the device status and the tests' results.

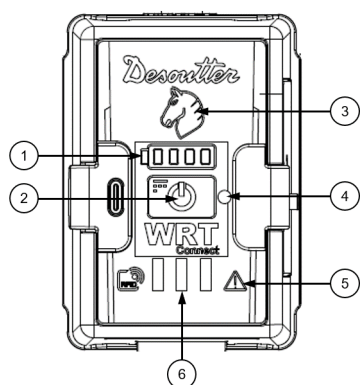

Position	Name	Description
1	Battery LEDs	LED indicators that communicate the battery charge level.
2	ON/OFF button	Physical button to turn on/off the WRT.

## Product Information

Position	Name	Description
3	Horse LED	LED indicators that communicate the result of a single test or batch depending on color and behavior.
4	Status LED	LED indicator that communicates different WRT statuses depending on color and behavior.
5	Warning LED	LED indicator that alerts on WRT critical statuses.
6	Result LEDs	LED indicator that confirms at startup that the WRT is turned on.

### LED system

#### Battery LEDs

##### WRT on

When the WRT is on, the Battery LEDs will behave as follow:

Battery LEDs	LEDs Behavior	Charge Level
▣▣▣▣	Steady white	Full (90% - 100 %)
▣▣▣▢	Steady white	High (75% - 89 %)
▣▣▣▢	Steady white	Medium (50% - 74 %)
▣▣▣▢	Steady white	Low (25% - 49 %)
▣▣▣▢	Blinking white	Empty (0% - 24 %)

##### WRT in standby mode and charging via USB cable

When the WRT is in standby mode and charging via USB cable, by default all Battery LEDs are off: ▣▣▣▣

To verify the battery charge level, press the ON/OFF button once and the Battery LEDs will behave as shown in the table above.

Once the battery is fully charged, all Battery LEDs automatically turn on and stay steady white: ▣▣▣▣

#### Status LEDs

Signaling LED	LED Behavior	Description
Status LED	Off	Wi-Fi connection off.
Status LED	Blinking blue	Wi-Fi connection in progress.
Status LED	Steady blue	Connected to Wi-Fi but not in measuring mode.
Status LED	Steady green	Connected to Wi-Fi and in measuring mode.
Status LED	Alternating green and blue	Wi-Fi disconnection occurred during measuring mode.
Status LED	Steady red	Wi-Fi connection failed.
Status LED	Blinking violet	Device set up as access point - no client connected.
Status LED	Steady violet	Wi-Fi connection in Access point mode on - one client connected.
Status LED	Off	Connection over USB cable.
Status LED	Steady red*	Zero torque check failed.
Status LED	Steady red*	Overloaded transducer.
Status LED	Steady red*	Date/Hour set up missing.
All LEDs	On	In bootloader mode for firmware upgrade.
Warning LED	Blinking yellow	Web User Interface resources upgrade on going.
Status LED	Blinking green	Free Angle Strategy test completed. To move to the next test in the batch, press the ON/OFF button.

\*A report on the occurred error is available on the **Diagnostic** page of the **WRT Web User Interface**.

#### Result LEDs

LEDs Behavior	Result	Description
Steady red	Single test NOK	Measured torque and/or angle are out of tolerance limits.

LEDs Behavior	Result	Description
Steady green	Single test OK	Measured torque and/or angle are within tolerance limits.
Blinking red	Batch NOK	At least one result in the batch is out of tolerance limits, or $C_m < C_m \text{ min}$ , or $C_{mk} < C_{mk} \text{ min}$ .
Blinking green	Batch OK	All batch results are within the tolerance limits, and $C_m \geq C_m \text{ min}$ , and $C_{mk} \geq C_{mk} \text{ min}$ .

## USB port

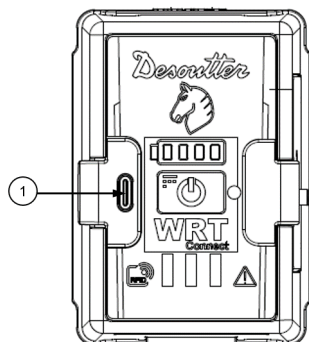

### 1 USB type-C port

The USB type-C port is available for the WRT first configuration and for charging the device battery.

The USB type-C port is also used for firmware upgrade (reserved to authorized Desoutter Service Personnel).

- ⓘ It is recommended to use the dual screw USB Type-C locking plug connector supplied with the WRT. Make sure to fasten the two screws until the plug is properly locked to the USB port.

## Installation

### Installation Instructions

#### How to install the battery

1. On the battery cover (1), move the lock lever (2) and hold it in place to unlock the clasp (3) that secures the cover to the body of the device. Then, open the battery cover.
2. Insert the battery (4) into the battery compartment (5) starting with the side facing the WRT user interface (6).
3. Close the battery cover (1) and lock the clasp (3).

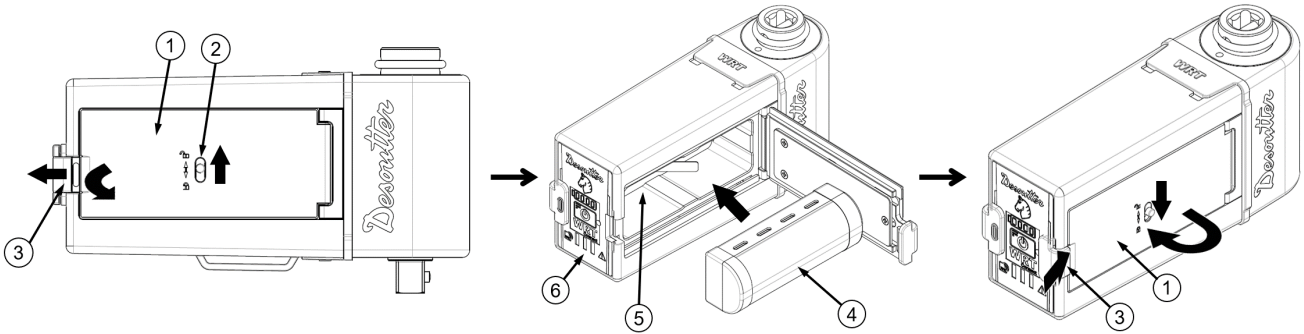

#### How to remove the battery

1. On the battery cover (1), move the lock lever (2) and hold it in place to unlock the clasp (3) that attach the cover to the body of the device. Then, open the battery cover.
2. Remove the battery (4) from the battery compartment (5) starting with the side facing the WRT user interface (6).
3. Close the battery cover (1) and lock the clasp (3).

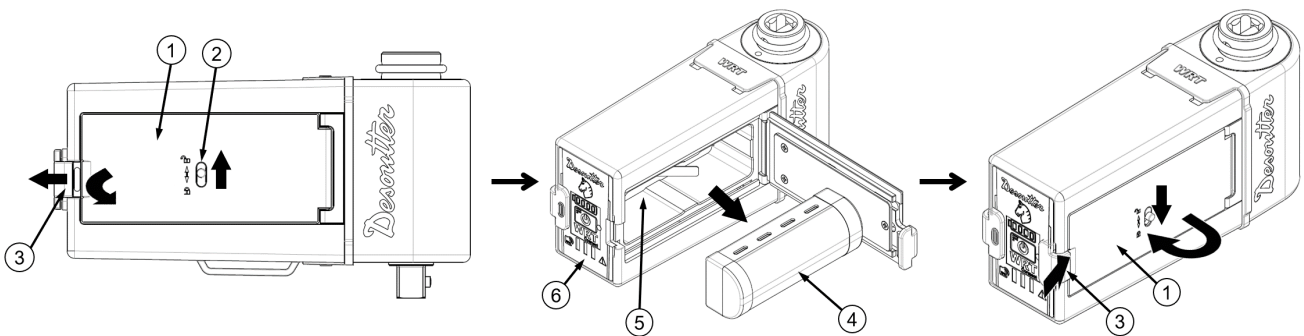

**i** The WRT is provided with a Hot Swap mode that allows the user to replace the battery without switching off the device first. After removing the battery, the device will remain in Hot Swap mode up to 30 seconds.

#### How to charge the battery

##### Using the USB cable

1. Turn on the WRT and open the cover of the USB type-C port (2) on the WRT user interface (1).
2. Connect the dual screw USB Type-C locking plug connector (3) to the WRT type-C port (2) and to the computer USB port (4).

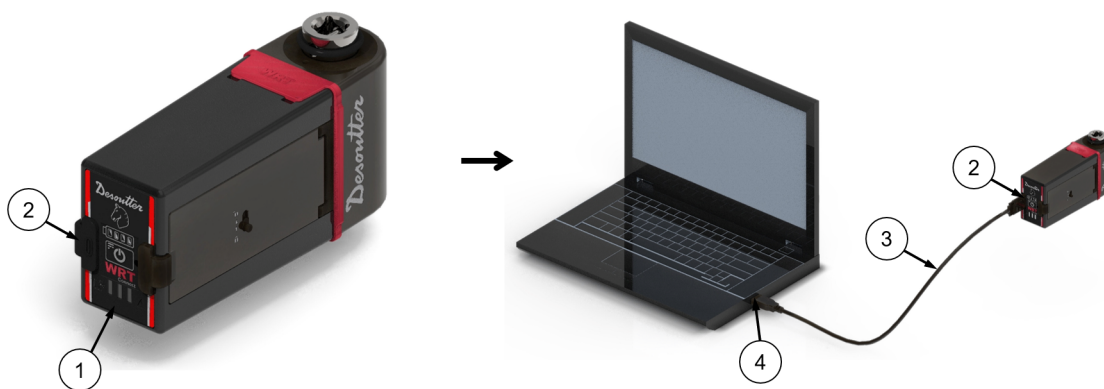

- ⓘ It is recommended to use dual screw USB Type-C locking plug connector supplied with the WRT. Make sure to fasten the two screws until the plug is properly locked to the USB port.
- ⓘ When the WRT is in standby mode and charging via USB cable, by default all Battery LEDs are off. To verify the battery level, press the ON/OFF button once. For more information, refer to *Battery LEDs [Page 10]*
- ⓘ When the WRT is connected via a USB cable, make sure that both the measurement equipment system and the WRT power supply system are correctly grounded.

### Using the QA-Charger

- ⓘ Use **only** the QA-Charger (P/N 6159364610) to recharge the WRT battery pack (P/N 6159365310).
1. Remove the battery from the WRT.  
For more information, refer to *How to remove the battery [Page 12]*.
  2. Connect the battery QA-Charger's power cable to the socket.
  3. Insert the battery into one of the adapters (1) on the QA-Charger.



- ⓘ For further information on how to install and operate the QA-Charger, refer to *QA-Charger Product Instructions* (615990140) available at <https://www.desouttertools.com/resource-centre>.

### How to turn on/off the WRT

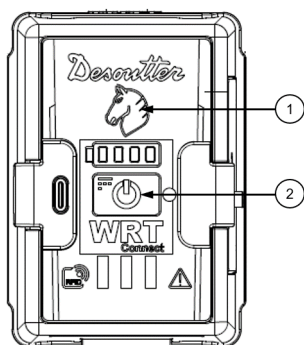

#### Turning off the WRT

1. On the WRT user interface, press the ON/OFF button (2) until the Horse LED (1) turns on.
2. As soon as the Horse LED turns on, release the ON/OFF button.

#### Turning off the WRT

On the WRT user interface press the ON/OFF button (2) until all LEDs turn off.

### How to install the anti rotation holder

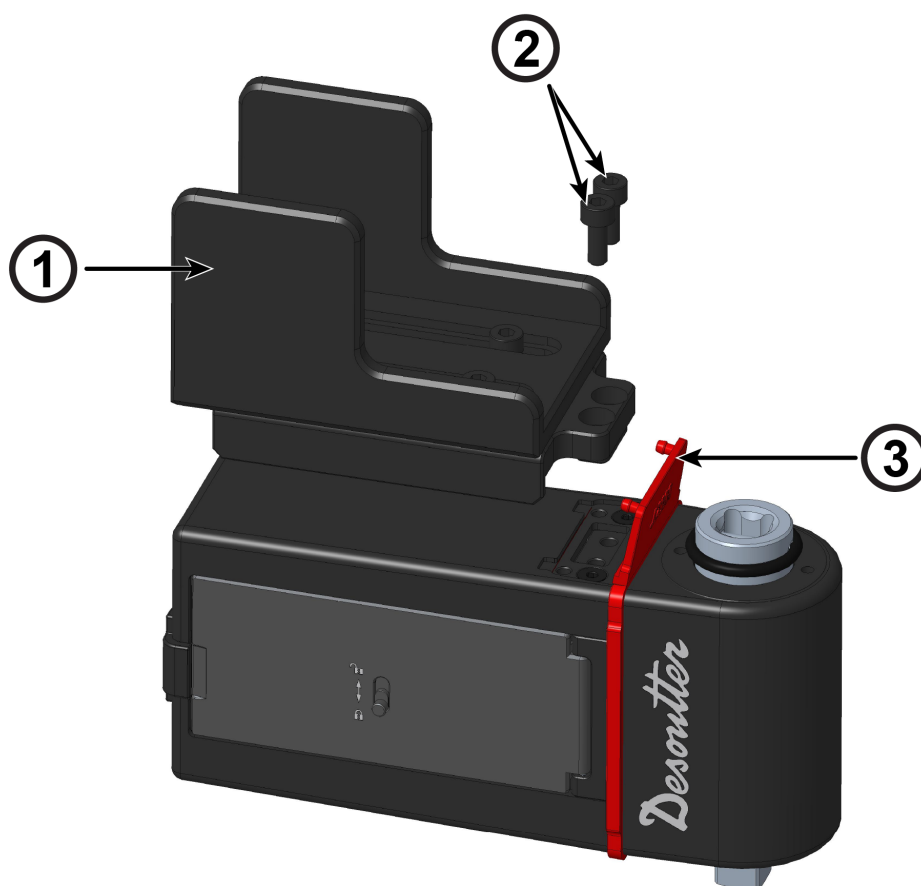

1. Lift the rubber gasket (3).
2. Install the anti rotation holder (1) with the screws (2) to the WRT.

### How to connect the WRT to the Web User Interface

1. Turn on the WRT.
2. Use the USB type-C port of the device to connect the WRT to the USB port of the computer.

3. Open a web browser and type in the address of the **WRT Web User Interface**: 169.254.1.1:8000

- i** The WRT accepts only one connection at a time. If you attempt to connect the WRT to the Web User Interface on different web pages or on different computers at the same time, connection will be refused.

### How to log into the Web User Interface

When you connect the WRT to the Web User Interface, a non-authenticated session is established.

In the right corner of the Web User Interface top bar, instead of username and role, the label **No session** is displayed. Refer to "*User roles and permissions [Page 15]*" for the allowed operations in the "**No session**" profile.

To log in and establish an authenticated session, a **CVI KEY** is required, which contains user credentials and role, in order to determine the associated authorization level.

It is also possible to configure the login as "Local session" using a password. Refer to "*Access Control [Page 21]*" and "*User roles and permissions [Page 15]*" for more information.

Once you have a **CVI KEY** with your credentials and role, do the following to log into the Web User Interface:

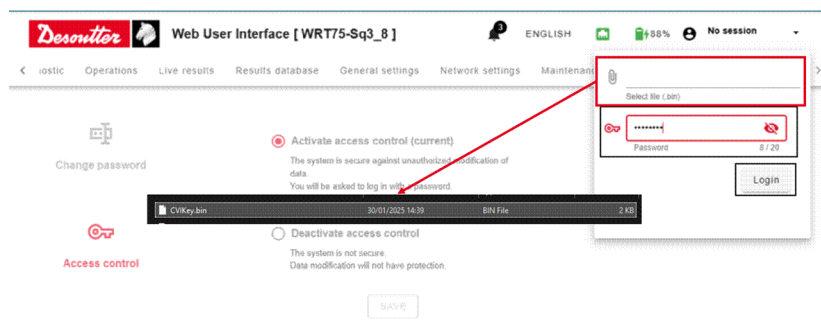

1. Connect the WRT to the Web User Interface.  
For more information, refer to *How to connect the WRT to the Web User Interface [Page 14]*.
2. Connect the **CVI KEY** to your computer.
3. In the right corner of the Web User Interface top bar, click the down-arrow.
4. In the login form, click **Attach**  to browse and select the `.bin` file contained in the **CVI KEY**.  
**i** It is also possible to save the file locally on your computer.
5. In the login form, click **Login**.

In the right corner of the Web User Interface top bar, username and role of the user who is currently logged in are displayed.

- i** The WRT Web User Interface uses a role-based authorization system. User permissions depend on the role assigned to the user. For further information, refer to *User roles and permissions [Page 15]*.
- i** If the **CVI KEY** file credentials are expired, it is still possible to log into the Web User Interface, but the user will have the same permissions as in the **No session** condition. In this case, a warning message informs the user about the credentials expiration, while the username and role labels are highlighted in yellow.
- i** If **Access Control** is enabled, the login is possible using a **CVI Key** or, alternatively, a **password**.

### How to log out of the Web User Interface

1. In the right corner of the Web User Interface top bar, click the down-arrow.
  2. In the login form, click **Logout**.
- i** After logging out, the Web User Interface returns to the **No session** condition.

### User roles and permissions

The WRT Web User Interface uses a role-based authorization system, meaning that user permissions and privileges depend on the role assigned to the user.

The following matrix outlines the user roles available for the WRT Web User Interface and the permissions associated with each role.

## Installation

	No session	Operator (CVI Key)	Production manager/ Q&A user (CVI Key)	Maintenance operator (CVI Key)	Administra- tor/ 3rd lab user (CVI Key)	Desouter Technician (CVI Key)	Local ses- sion
View current lan- guage	✓	✓	✓	✓	✓	✓	✓
View Wi-Fi con- nection status	✓	✓	✓	✓	✓	✓	✓
View battery level	✓	✓	✓	✓	✓	✓	✓
Use Virtual Assis- tant for configura- tion	✓	✓	✓	✓	✓	✓	✓
Read Identification information	✓	✓	✓	✓	✓	✓	✓
Read calibration certificate	✓	✓	✓	✓	✓	✓	✓
Export calibration certificate	✓	✓	✓	✓	✓	✓	✓
Print calibration certificate	✓	✓	✓	✓	✓	✓	✓
Add a new calibra- tion certificate	✓	✓	✓	✓	✓	✓	✓
Remove an existing calibration certifi- cate (except Production Calibration Report)	✓	✓	✓	✓	✓	✓	✓
Edit / remove Pro- duction Calibration Report	✗	✗	✗	✗	✗	✗	✗
Launch diagnostic	✓	✓	✓	✓	✓	✓	✓
Read, export and print diagnostic re- port	✓	✓	✓	✓	✓	✓	✓
View tools configu- ration	✓	✓	✓	✓	✓	✓	✓
Add a new tool	✓	✓	✓	✓	✓	✓	✓





























	No session	Operator (CVI Key)	Production manager/ Q&A user (CVI Key)	Maintenance operator (CVI Key)	Administra- tor/ 3rd lab user (CVI Key)	Desoutter Technician (CVI Key)	Local ses- sion
Edit an existing tool configuration	✓	✓	✓	✓	✓	✓	✓
Remove an existing tool	✓	✓	✓	✓	✓	✓	✓
View operations configuration	✓	✓	✓	✓	✓	✓	✓
Add a new operation	✓	✓	✓	✓	✓	✓	✓
Edit an existing operation configuration	✓	✓	✓	✓	✓	✓	✓
Remove an existing operation	✓	✓	✓	✓	✓	✓	✓
Start operation	✓	✓	✓	✓	✓	✓	✓
Enable/disable Demo mode	✓	✓	✓	✓	✓	✓	✓
Create Demo mode test	✓	✓	✓	✓	✓	✓	✓
Edit Demo mode test	✓	✓	✓	✓	✓	✓	✓
Start Demo mode test	✓	✓	✓	✓	✓	✓	✓
View Live Results page	✓	✓	✓	✓	✓	✓	✓
Print Live Results report	✓	✓	✓	✓	✓	✓	✓
Export Live Results report	✓	✓	✓	✓	✓	✓	✓
View and refresh Results Database	✓	✓	✓	✓	✓	✓	✓
Export and print Results Database	✓	✓	✓	✓	✓	✓	✓

## Installation

	No session	Operator (CVI Key)	Production manager/ Q&A user (CVI Key)	Maintenance operator (CVI Key)	Administra- tor/ 3rd lab user (CVI Key)	Desouter Technician (CVI Key)	Local ses- sion
Edit General Set- tings	✗	✗	✓	✓	✓	✓	✓
Edit WRT network settings	✗	✗	✓	✓	✓	✓	✓
View WRT network settings	✓	✓	✓	✓	✓	✓	✓
Upgrade application firmware	✗	✗	✗	✗	✗	✓	✗
Upgrade Wi-Fi module firmware	✗	✗	✗	✗	✗	✓	✗
Export Log files	✓	✓	✓	✓	✓	✓	✓
Print Log files	✓	✓	✓	✓	✓	✓	✓
Delete Log files	✗	✗	✓	✗	✓	✓	✗
Save locally results and configuration	✗	✗	✓	✗	✓	✓	✗
Delete all opera- tions	✗	✗	✓	✗	✓	✓	✗
Delete all results	✗	✗	✓	✗	✓	✓	✗
Delete all curves	✗	✗	✓	✗	✓	✓	✗
Delete all diagnos- tic reports	✗	✗	✓	✗	✓	✓	✗
Reset to factory set- tings	✗	✗	✓	✗	✓	✓	✗
Disable Ethernet over USB	✓	✓	✓	✓	✓	✓	✗
Show Virtual Assis- tant	✓	✓	✓	✓	✓	✓	✓
Modify Access Control (When Ac- tive)	✗	✗	✗	✗	✗	✗	✓
Modify Access Control (When In- active)	✗	✗	✓	✓	✓	✓	N.A.





## Initial Configuration

### Web User Interface icons and buttons

-  OK result
-  NOK result
-  Result value over the upper limit value.
-  Result value below the lower limit value.
-  Select date
-  Select time
-  Sync with local time
-  Battery level
-  Battery charging
-  Delete
-  Download
-  Print
-  Refresh
-  Export
-  Upload calibration certificate
-  Calculate the calibration value
-  Start a new calibration operation
-  View curve
-  Upload file
-  Edit
-  View details
-  View notifications
-  Wi-Fi connection on
-  Wi-Fi connection off
-  Device set up as access point - no client connected
-  Device set up as access point - one client connected
-  Ethernet over USB connection on
-  No connected device found
-  Action required

### How to configure the WRT using the Virtual Assistant

1. Connect the WRT to a computer via USB cable.
2. Open a web browser and type in the address of the WRT web user interface: 169.254.1.1:8000.
3. In the bottom-right corner of the Web User Interface landing page, click **Yes** in the **Virtual Assistant** pop-up.
4. Click **Get Started** to start the assisted configuration.

- In the **System setup** category, define the following parameters for the connected device:
  - Device description*: type a description of the device you are configuring.
  - Measure unit*: in the drop-down list, select a unit of measurement.
  - Language*: In the drop-down list, select a language.
  - Device date*: Click **Calendar**  to select date, or click **Sync date/time**  to set up the local date and time.
  - Device date*: Click **Clock**  to set a time, or click **Sync date/time**  to set up the local date and time.

Then, click **Save**.

If you don't have to edit any parameter, click **Next** to move to the next category.

- In the **Network setup** category, define the Wi-Fi mode and the relevant network and wireless parameters for the connected device.

For more information, refer to *How to edit Network Settings [Page 29]*.

Then, click **Save**.

If you don't have to edit any parameter, click **Next** to move to the next category.

- In the **Demo mode** category, select an *Operation type*:
  - Click wrench
  - Nutrunner
  - Pulse tool
  - Peak
  - Free angle

If you don't want to edit or run a demo test, click **Next**.

- In the category of the selected *Operation type*, click **Edit**  to configure the demo test, or click **Run**  to run the test using the default settings.

For more information on how to configure a demo test, refer to *How to edit a demo test [Page 31]* and to *Demo test parameters [Page 31]*.

After configuring the editable parameters in the demo test window, click **Save**.

Your device is set up and ready to run the configured demo test. In the **Navigation menu**, click **Live result** to monitor in real time test results.

### Relevant Information

-  [How to navigate Live Results \[40\]](#)

### How to upgrade the application firmware

 The operation described in this section requires permissions assigned only to specific user roles. For more information, refer to *User roles and permissions [Page 15]*.

 To perform the following operation, the WRT battery charge level must be above 15%.

- Turn on the WRT and connect it to the Web User Interface with a wireless connection or via USB cable.
- Log into the WRT Web User Interface with an account that has a user role with the required permissions.
- On the **Navigation menu**, select **Maintenance**.
- On the left panel of the **Maintenance** page, in the **Version** category, look for the item **Upgrade Application**.
- Next to **Upgrade Application**, click **Attach**  and browse the .tar file containing the application firmware upgrade.
- Next to **Upgrade Application**, click **Upgrade**.
- In the confirmation dialog, click **Yes**.

 Do not refresh or change the Web User Interface page and do not disconnect the WRT while uploading the upgrade file, otherwise the operation will fail.

Once the upgrade file is successfully uploaded, a notification is displayed on the Web User Interface.

## 8. Restart the WRT.

The WRT LED indicators behave as follows:

1. Warning LED blinking, all other LEDs steady on: application upgrade is being installed on the WRT.
2. Warning LED blinking, Horse LED steady on: Steady: Web User Interface upgrade is being installed.
3. All LED indicators off: upgrade installation is completed.

9. To confirm that the application firmware has been successfully upgraded, refresh the Web User Interface page and go to **Identification**. If the version number displayed next to the item **Application version** matches the one of the firmware upgrade version, the upgrade was successful.**Relevant Information**

 How to connect the WRT to the Web User Interface [14]

**How to upgrade the Wi-Fi module firmware**

 The operation described in this section requires permissions assigned only to specific user roles. For more information, refer to *User roles and permissions [Page 15]*.

 To perform the following operation, the WRT battery charge level must be above 15%.

When an upgrade of the Wi-Fi module firmware is required, in the **Network Settings** page, under **WiFi Info**, the version number of the firmware currently installed is marked with the action required icon .

1. Turn on the WRT and connect it to the Web User Interface via USB cable.
2. Log into the WRT Web User Interface with an account that has a user role with the required permissions.
3. On the **Navigation menu**, select **Maintenance**.
4. On the left panel of the **Maintenance** page, in the **Version** category, look for the item **Upgrade WiFi**.
5. Next to **Upgrade WiFi**, click **Attach**  and browse the .rps file containing the Wi-Fi firmware upgrade.
6. Next to **Upgrade WiFi**, click **Upgrade**.
7. In the confirmation dialog, click **Yes**.

 Do not refresh the Web User Interface page and do not disconnect the WRT while uploading the upgrade file, otherwise the operation will fail.

Once the upgrade file is successfully uploaded, a notification is displayed on the Web User Interface.

## 8. Restart the WRT.

The WRT LED indicators behave as follow:

1. Warning LED blinking, Horse LED steady on: upgrade file is being transferred to the WRT.
2. Warning LED steady on, Horse LED steady on: upgrade file is being installed.
3. Off: upgrade file installation is completed.

9. To confirm that the Wi-Fi module firmware has been successfully upgraded, refresh the Web User Interface page and go to **Network Settings**. Under **WiFi Info**, if the version number displayed next to the item **Firmware** matches the one of the firmware upgrade version, the upgrade was successful.**Relevant Information**

 How to connect the WRT to the Web User Interface [14]

**Access Control**

 To prevent unauthorized persons from changing network assets, the user enables Access Control on the WRT.

**Getting Access Control**

To manage and change the Access Control setup, use the new tab on the navigation bar.

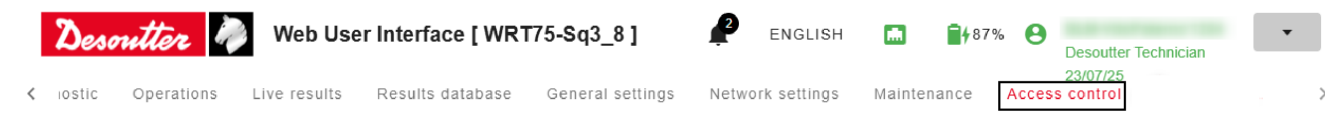

## Enable the Access Control

**i** To enable this access control, the user must authenticate with a **CVIkey**.

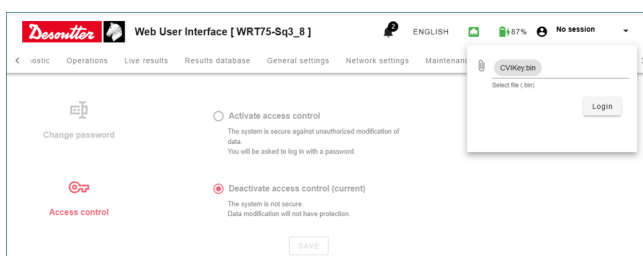

1. Click "No Session" to sign in.



**i** A window appears to select the **CVIkey** provided by the authorized person.

2. Select "CVIkey"
3. Click "Login"

**i** Access Control is deactivated by default.

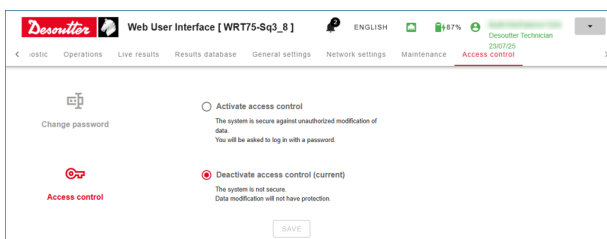

4. Select "Activate Access Control"

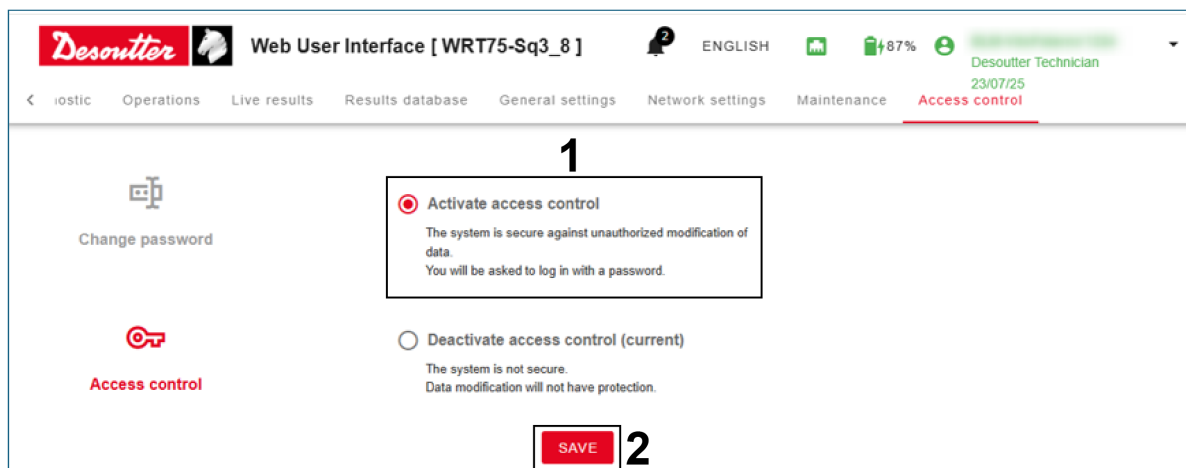

5. Click "SAVE".

**i** A window will appear for the user to create a password for Access Control.

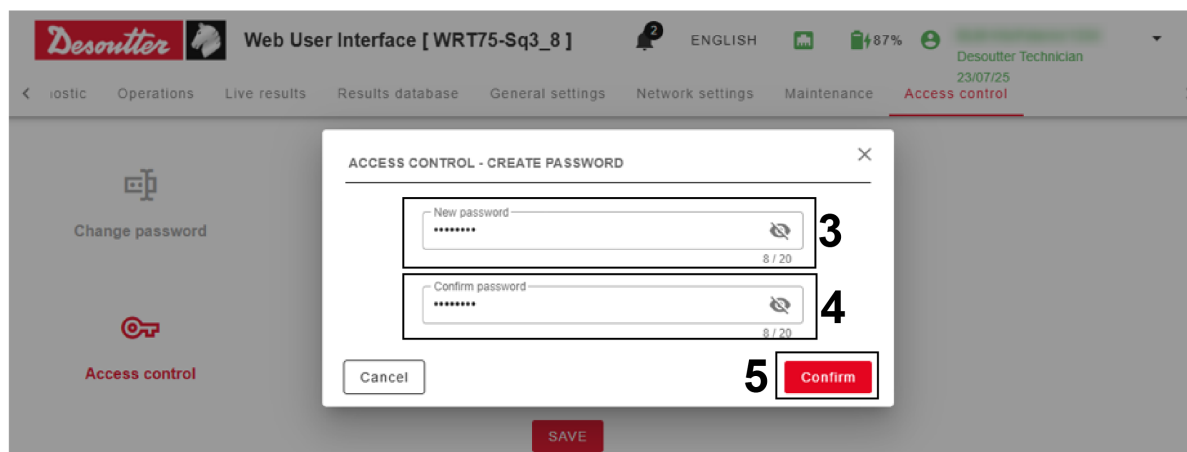

6. Enter "New password".

7. Enter "Confirm password".

8. Click "Confirm".

### Disable the Access Control

To disable the access control click on "Deactivate Access Control" and then click the "Save" button.

**i** A warning window appears to inform the user of the cause.

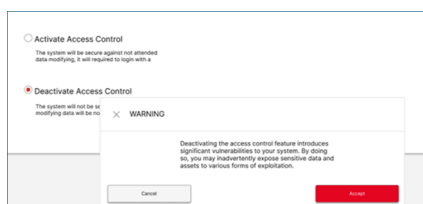

Click "Accept" to continue.

### Change Network Settings

**i** If Access Control is enabled, the user must log in with a password to change network settings.

# Installation

1. Click "**No Session**" to sign in.

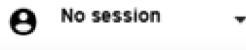

- i** A password window appears.

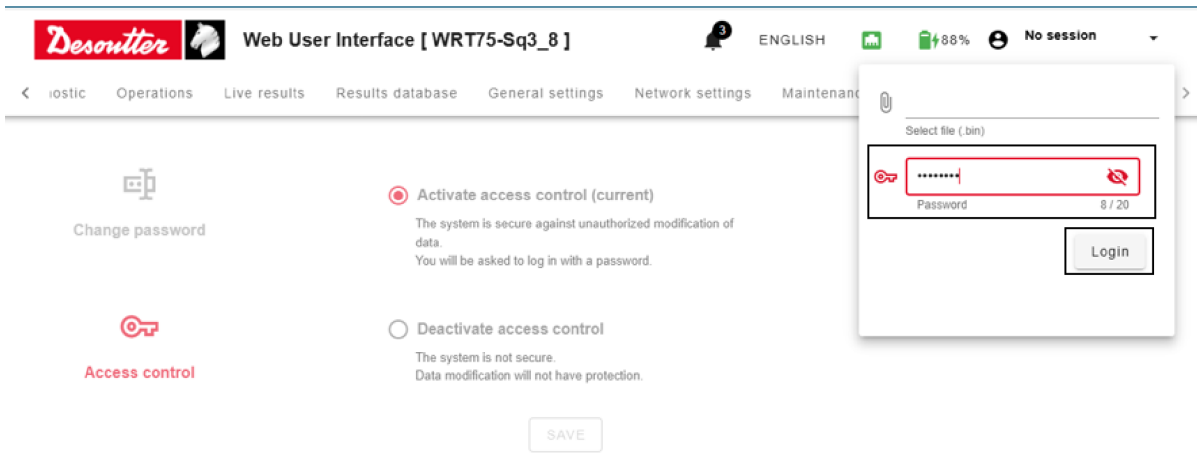

2. Enter user password in "**Password**" field.
3. Click "**Login**" to get access of the network settings.
4. To log out of the local session, click "**Logout**".

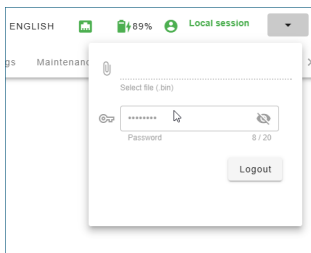

## How to Change the Password

1. Log in with your password (local session).
2. Go to **Access Control** section.

- i** Make sure **Access Control** is enabled

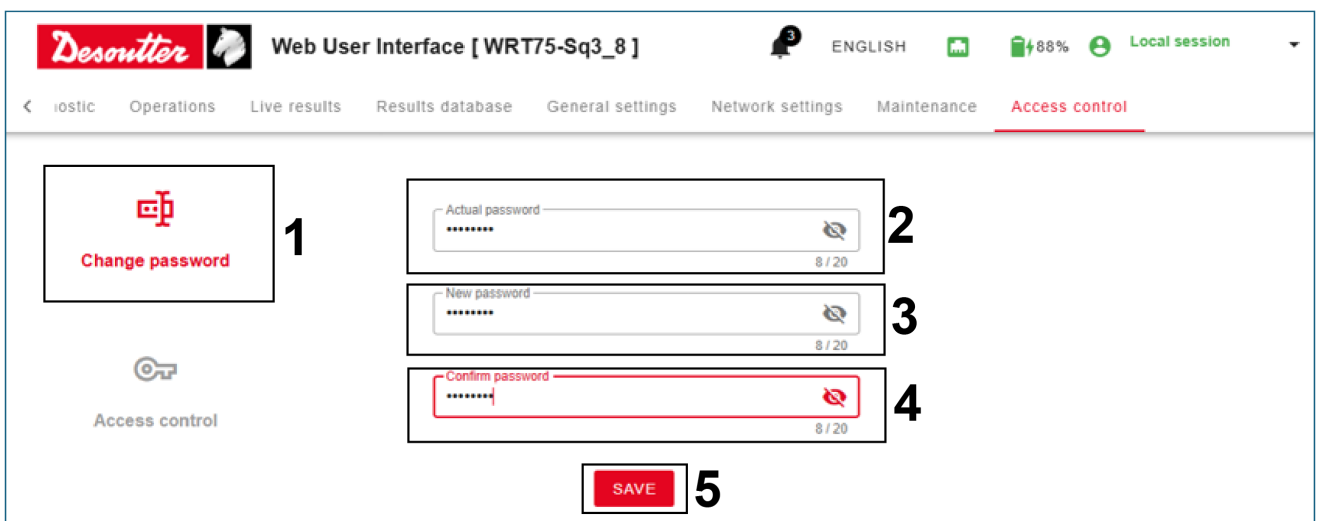

1. Click "**Change password**" in the access control
2. Enter "**Actual password**".
3. Enter "**New password**".
4. Enter "**Confirm password**".
5. Click "**Save**" to change the password.

## Open Protocol Server

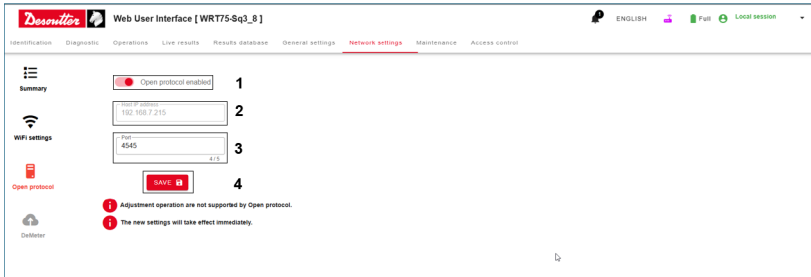

In the **Home** page, tap **Network Settings > Open protocol**.

### Enable the Open protocol

1. Tap the *toggle* switch to enable the **Open Protocol** server.
  - ⓘ The **Open Protocol** does not support adjustment operations.
2. Assign the *IP address*.
  - ⓘ The *IP address* is assigned automatically according to the network setting.
3. Assign the **Open protocol** port.
  - ⓘ Default: 4545.
4. Tap **Save**.
  - ⓘ The new setting becomes active immediately.

### Open Protocol MID Data

MID	Description	Revision Range
0001	Communication start	0-5
0002	Communication start acknowledge	0-5
0003	Communication stop	0-1
0004	Command error	0-1
0005	Command accepted	0-1
0010	Pset ID upload request	0-4
0011	Pset ID upload response	0-4
0012	Pset data upload request	0-5 (no rev 3 and 4)
0013	Pset data upload reply	0-5 (no rev 3 and 4)
0014	Pset selected subscribe	0-1
0015	Pset selected	0-2
0016	Pset selected acknowledge	0-1
0017	Pset selected unsubscribe	0-1
0018	Select Pset	0-1
0040	Tool data upload request	0-5
0041	Tool data upload reply	0-5
0042	Disable tool	0-1

## Installation

---

<b>MID</b>	<b>Description</b>	<b>Revision Range</b>
0043	Enable tool	0-1
0050	Vehicle ID number download request	0-1
0060	Last tightening result data subscribe	0-11
0061	Last tightening result data	0-11
0062	Last tightening result data acknowledge	0-1
0063	Last tightening result data unsubscribe	0-1
0064	Old tightening result upload request	0-1
0065	Old tightening result upload response	0-11
0080	Read time upload request	0-1
0081	Read time upload response	0-1
0082	Set time	0-1
0150	Identifier download request	0-1
0156	Reset latest identifier	0-1
0157	Reset all identifiers	0-1
9999	Keep alive message	0-1

---

## Operation

### Configuration Instructions

#### How to configure the WRT

- i** Actions and features described in this section might require permissions assigned only to specific user roles. For more information, refer to *User roles and permissions [Page 15]*.

#### How to view WRT information

On the Web User Interface **Navigation menu**, click **Identification**.

The **Identification** page displays the following information about the connected WRT:

#### Identification category

<b>Serial number</b>	Serial number of the connected device.
<b>Model</b>	Type of device.
<b>Capacity</b>	Capacity of the connected device.
<b>Reference</b>	Reference of the connected device.
<b>Application version</b>	Firmware version currently installed in the connected device.
<b>Production date</b>	Production date of the connected device.

#### Status category

<b>Battery charge</b>	Current battery charge level of the connected device.
<b>Wi-Fi</b>	Wi-Fi connection status. The status can be: <ul style="list-style-type: none"> <li>• Connected.</li> <li>• Disconnected.</li> </ul>
<b>Batch status</b>	Current status of the ongoing batch.
<b>Device date</b>	Date and time set for the device.

#### Transducer category

- i** If the transducer has been overloaded, the warning message `Transducer is over-torqued` appears next to the **Transducer** category.

<b>Nominal torque</b>	Torque capacity of the connected device.
<b>Max torque</b>	Maximum torque value readable by the connected device.
<b>Min torque</b>	Minimum torque value readable by the connected device.
<b>Overload torque</b>	Overload torque value.
<b>Last torque overload</b>	Value of the last torque overload.
<b>Last torque overload date</b>	Date and time of the last torque overload.
<b>Number of torque overload</b>	Number of overloads applied on the transducer.
<b>Sensitivity</b>	Sensitivity value of the torque transducer.
<b>Angular resolution</b>	Angular resolution of the encoder.
<b>Tightening counter</b>	Number of tightenings applied to the device so far.
<b>Number of pulses</b>	Number of pulses applied to the device so far.
<b>Production date</b>	Production date of the transducer.

#### Calibration category

<b>Last calibration date</b>	Date of the last calibration performed on the device.
<b>Next calibration date</b>	Date of the next scheduled calibration to perform on the device.
<b>Calibration status</b>	Current calibration status. The status can be: <ul style="list-style-type: none"> <li>• Currently valid.</li> <li>• Expired: WRT requires a calibration.</li> </ul>





### Calibration Report History category

The **Calibration Report History** category lists the calibration reports stored in the device. The list is defined by the following columns:

Index	Index number of the calibration report.
Upload date	Date when the calibration report has been uploaded.
Comment	Additional comment left by the operator.

According to the user role, the **Calibration Report History** category also enables the user to upload new calibration reports; to export and save reports locally; to edit and delete reports.

#### How to upload calibration reports

1. On the **Navigation menu**, select **Identification**.
2. Below the **Calibration Report History** list, click the **Attach**  to browse and select the calibration report to upload.  
 The supported file format is `.pdf`, and the maximum supported file size is 1 Mb.
3. In the Date field, click **Calendar**  and select a date for the calibration report.
4. If required, add a comment in the **Comment** box.
5. Click **Add**  to add the new certificate to the list.

-  The **Calibration Report History** can list up to 11 calibration reports including the Factory Calibration Report, which cannot be deleted.  
If you already have 11 calibration reports listed and add a new one, the oldest report is automatically deleted to be replaced by the new calibration report.

#### How to download calibration reports



1. On the **Navigation menu**, select **Identification**.
2. In the **Calibration Report History** list, select the checkbox next to the calibration report(s) of interest. On the right panel, you can see a preview of the selected report.
3. Below the **Calibration Report History** list, click **Download**  and save the report(s) locally as `.pdf` file.

#### How to delete calibration reports

1. On the **Navigation menu**, select **Identification**.
2. In the **Calibration Report History** list, select the check box next to the calibration report to delete.
3. Below the **Calibration Report History** list, click **Delete** .
4. In the confirmation dialog, click **Yes** to confirm the operation.

**How to edit General Settings**

1. On the Web User Interface **Navigation menu**, select **General Settings** and edit the settings as required:

Parameter	Description
<i>Device description</i>	Type a name for the connected WRT.
<i>Unit</i>	In the drop-down list, select the default unit of measurement for operations from the following options: <ul style="list-style-type: none"> <li>• Nm</li> <li>• kg/m</li> <li>• kg/cm</li> <li>• lb/ft</li> <li>• lb/in</li> <li>• oz/ft</li> <li>• oz/in</li> <li>• kPm</li> <li>• dNm</li> </ul> Default value: Nm.
<i>Unit for Demo mode</i>	In the drop-down list, select the default unit of measurement for Demo tests from the following options: <ul style="list-style-type: none"> <li>• Nm</li> <li>• kg/m</li> <li>• kg/cm</li> <li>• lb/ft</li> <li>• lb/in</li> <li>• oz/ft</li> <li>• oz/in</li> <li>• kPm</li> <li>• dNm</li> </ul> Default value: Nm.
<i>Language</i>	In the drop-down list, select the default language.
<i>Device date and time</i>	Click <b>Calendar</b>  and <b>Clock</b>  to select the device date and time.  Click <b>Sync date/time</b>  to set the current local date and time as device date and time.
<i>Date format</i>	In the drop-down list, select the default date and time format from the following options: <ul style="list-style-type: none"> <li>• yy/MM/dd HH:mm</li> <li>• dd/MM/yy HH:mm</li> <li>• MM/dd/yy HH:mm</li> </ul>
<i>Statistics</i>	In the drop-down list, select the default statistics type for operations from the following options: <ul style="list-style-type: none"> <li>• ISO(3534-2:2006)</li> <li>• CNOMO</li> </ul> Default value: ISO(3534-2:2006).

2. Click **Save**.

**How to edit Network Settings**

1. On the Web User Interface **Navigation menu**, select **Network Settings**.
2. On the sidebar, select **WiFi Settings**.

## Operation

- Under *WiFi mode*, in the drop-down list select a Wi-Fi mode for the connected device from the following options:

Mode	Description
<b>Disabled</b>	Disable the Wi-Fi module of the connected device.
<b>Infrastructure mode</b>	Set up Wi-Fi connection using the local network.
<b>Access point mode</b>	Set up the WRT as access point for Wi-Fi connection.

Click **Set**.

- Depending on the selected *WiFi mode*, configure the relevant parameters either in the **Infrastructure mode** category or in the **Access point mode** category that is displayed below the *WiFi mode* drop-down list.
- Click **Save**.  
Alternatively, to apply your changes to the settings, you can also click **Set** next to the *WiFi mode* drop-down list.

### Infrastructure mode parameters

#### Network parameters

Parameter	Description
<i>Allocation method for IP address</i>	In the drop-down list, select the allocation method for IP address.
<i>Host IP address</i>	Type the host IP address.
<i>Subnet mask</i>	Type the subnet mask
<i>Gateway</i>	Type the network gateway.
<i>Host name</i>	Type the host name.
<i>Port</i>	Type a port or leave default value.
<i>Mac address</i>	This parameter is not editable.

#### Wireless parameters

Parameter	Description
<i>Network name (SSID)</i>	Type the name of the network.
<i>Security type</i>	In the drop-down list, select the security type to apply to the wireless network.
<i>Security key</i>	Type the network password.
<i>Radio band</i>	In the drop-down list, select the radio band from the following options: <ul style="list-style-type: none"><li>• <b>Auto</b></li><li>• <b>2.4 GHz</b></li><li>• <b>5 GHz</b></li></ul>
<i>Channel</i>	Select the radio channel. If <i>Radio band</i> is set to <b>Auto</b> , <i>Channel</i> is automatically set to <b>Auto</b> .

### Access point mode parameters

#### Network parameters

Parameter	Description
<i>Host IP address</i>	Type the host IP address.
<i>Subnet mask</i>	Type the subnet mask
<i>Host name</i>	Type the host name.
<i>Port</i>	Type a port or leave default value.
<i>User WRT as DHCP server</i>	Select the checkbox to use the WRT as DHCP Server for the network.

#### Wireless parameters

Parameter	Description
<i>Network name (SSID)</i>	Type the name of the network.

Parameter	Description
<i>Security type</i>	In the drop-down list, select the security type to apply to the wireless network.
<i>Encryption type</i>	In the drop-down list, select the encryption type to apply to the wireless network.
<i>Security key</i>	Type the network password (minimum length: 8 characters).
<i>Radio band</i>	In the drop-down list, select the radio band from the following options: <ul style="list-style-type: none"> <li>• <b>Auto</b></li> <li>• <b>2.4 GHz</b></li> <li>• <b>5 GHz</b></li> </ul>
<i>Channel</i>	Select the radio channel. If <i>Radio band</i> is set to <b>Auto</b> , <i>Channel</i> is automatically set to <b>Auto</b> .

- ❗ If you connect the WRT to the computer via USB cable when the device is working as access point, the wireless connection automatically turns off.  
To connect the WRT via USB cable and still keep the wireless connection on, disable the Ethernet over USB connection as instructed in section *How to enable/disable the Ethernet over USB connection [Page 69]*.

## How to configure demo Tests

### How to enable/disable the Demo mode

- ❗ The operation described in this section requires permissions assigned only to specific user roles. For more information, refer to *User roles and permissions [Page 15]*.
1. On the Web User Interface **Navigation menu**, select **Operations**.
  2. On the **Operations** page, click the switch next to **Demo mode** to enable or disable the Demo Mode.

### Relevant Information

📖 How to run a demo test [39]

### How to edit a demo test

1. On the Web User Interface **Navigation menu**, click **Operations**.
2. On the **Operations** page, enable the **Demo mode**.  
For further information, refer to *How to enable/disable the Demo mode [Page 31]*.
3. On the Demo mode menu, select the *Operation type* of interest to expand the category. The available operation types are the following:
  - **Click wrench**
  - **Nutrunner**
  - **Peak**
  - **Pulse tool**
  - **Free angle**
4. In the category of the selected operation type, click **Edit** .
5. Edit the parameters as required. For more information, refer to *Demo test parameters [Page 31]*.
  - ❗ In Demo mode, some parameters are fixed and cannot be edited.  
The availability of editable parameters also depends on the selected *Operation type*.
6. Click **Save**.

### Relevant Information

📖 How to run a demo test [39]

📖 Operation types [51]

### Demo test parameters

In Demo mode, some test parameters can be edited while other are fixed.

- ❗ The availability of parameters depends on the selected *Operation type*.

## Operation

### Editable parameters

Parameter	Description	Available with operation types:
<i>Max torque</i>	Type the torque upper limit value to get an OK result.	Click wrench Nutrunner Peak Pulse tool
<i>Min torque</i>	Type the torque lower limit value to get an OK result.	Click wrench Nutrunner Peak Pulse tool
<i>Start torque</i>	Type the torque value from which the test starts.	Click wrench Nutrunner Peak Pulse tool
<i>Max angle</i>	Type the angle upper limit value to get an OK result.	Nutrunner Peak Free angle
<i>Min angle</i>	Type the angle lower limit value to get an OK result.	Nutrunner Peak Free angle
<i>Target angle</i>	Type the target angle value for the operation.	Free angle
<i>End time</i>	Type the end cycle time. The test ends when the torque drops beneath the <i>Start torque</i> value for a time longer than <i>End time</i> value. For Free Angle strategy, the test ends only after the angle is stable for a time longer than the <i>End time</i> value. Default value: <b>0.1</b> . Value range: <b>0.1 - 5</b> .	Click wrench Nutrunner Peak Pulse tool Free angle
<i>Torque factor K</i>	Type the coefficient to correct the torque value read by the WRT in order to match the real torque provided by a Pulse Tool on a joint (residual torque). The value is in thousandth and must be set between 500 and 1000.	Pulse tool
<i>Direction</i>	Select the tightening direction: <ul style="list-style-type: none"> <li>• <b>Clockwise:</b> the test must be run in clockwise direction.</li> <li>• <b>Counterclockwise:</b> the test must be run in counterclockwise direction.</li> <li>• <b>Clockwise and counterclockwise:</b> run the test both in clockwise and counterclockwise direction</li> </ul>	Click wrench Nutrunner Peak Pulse tool Free angle

Parameter	Description	Available with operation types:
<i>Frequency cut</i>	Select the frequency cut to be applied to the torque samples measured by the WRT.	Click wrench Nutrunner Peak Pulse tool
<i>Peak monitor</i>	Select the requisites for a peak to be considered the test result: <ul style="list-style-type: none"> <li>• <b>Result at first peak:</b> the first peak detected in the test is considered as result.</li> <li>• <b>Result at last peak:</b> the last peak detected in the test is considered as result.</li> </ul> In demo mode, <i>Peak monitor</i> is editable only for <b>Nutrunner</b> operation type.	Nutrunner
<i>Batch count</i>	Select the checkbox to configure the operation as a batch.	Click wrench Nutrunner Peak Pulse tool Free angle
<i>Batch size</i>	If the <i>Batch count</i> is selected, this parameter specifies how many times the test must be run. The maximum value is <b>99</b> . For Free angle strategy <i>Batch size</i> must be between <b>10</b> and <b>30</b> .	Click wrench Nutrunner Peak Pulse tool Free angle

**Fixed parameters**

Parameter	Description
<i>Check type</i>	In Demo mode, the <i>Check type</i> is automatically set according to the selected strategy and cannot be edited: <ul style="list-style-type: none"> <li>• <b>Only torque:</b> to have an OK result, the torque value must be within the set limits (regardless of the angle result). Fixed value for <b>Click wrench</b> and <b>Pulse tool</b> operation types.</li> <li>• <b>Only angle:</b> to have an OK result, the angle value must be within the set limits (regardless of the torque result). Fixed value for <b>Free angle</b> operation type.</li> <li>• <b>Torque and angle:</b> to have an OK result, both torque and angle values must be within the set limits. Fixed value for <b>Peak</b> and <b>Nutrunner</b> operation types.</li> </ul>
<i>Test type</i>	In Demo mode, the <i>Test type</i> is set to <b>Cm/Cmk</b> .
<i>Cm min</i>	Minimum Cm value to get an OK result. In Demo Mode <i>Cm min</i> is set to <b>1,67</b> .
<i>Cmk min</i>	Minimum Cmk value to get an OK result. In Demo Mode <i>Cmk min</i> is set to <b>1,67</b> .
<i>First threshold</i>	According to the selected strategy, this threshold is used to detect either the torque peak value or the click point of a wrench. Set value depends on the selected <i>Operation type</i> .

Parameter	Description
<i>Second threshold</i>	According to the selected strategy, this threshold is used to exclude from the analysis the part of the curve below a certain value in order to detect either the proper torque peak or the proper click point. Set value depends on the selected <i>Operation type</i> .
<i>Measure unit</i>	In Demo mode, unit of measurement is set to <b>Nm</b> .
<i>Peak monitor</i>	This parameter defines the requisites for a peak to be considered the test result. In Demo mode, the <i>Peak monitor</i> for <b>Click Wrench</b> operation is set to <b>Peak Click</b> : the first peak (click point) is considered the result of the test.
<i>Statistics type</i>	Type of statistics calculated by the WRT. In Demo Mode the statistics type is set to <b>ISO (3534-2:2006)</b> .

### Relevant Information

- 📖 Operation types [51]

### How to configure tools

**i** Actions and features described in this section might require permissions assigned only to specific user roles. For more information, refer to *User roles and permissions [Page 15]*.

#### How to add a tool

1. On the Web User Interface **Navigation menu**, click **Operations**.
2. In the right panel of the **Operations** page, click **Add Tool**.
3. In the **Tool** window, configure the new tool parameters.  
For more information, refer *Tool parameters [Page 34]*.
4. Click **Save**.

#### How to edit a tool

1. On the Web User Interface **Navigation menu**, click **Operations**.
2. In the tools list, click **Edit**  next to the tool to edit.
3. In the **Tool** window, edit the parameters of interest.  
For more information, refer to *Tool parameters [Page 34]*.
4. Click **Save**.

### Tool parameters

Parameter	Description
<i>Tool name</i>	Assign a name to the tool.
<i>Serial number</i>	Type the tool's serial number.
<i>Strategy</i>	In the drop-down list, select the tool's strategy from the following options: <ul style="list-style-type: none"><li>• <b>Click wrench.</b></li><li>• <b>Nutrunner.</b></li><li>• <b>Peak.</b></li><li>• <b>Pulse tool.</b></li></ul>
<i>Max torque</i>	Type the tool's maximum torque.
<i>Min torque</i>	Type the tool's minimum torque.

Parameter	Description
<i>Unit</i>	In the drop-down list, select the unit of measurement to use from the following options: <ul style="list-style-type: none"> <li>• Nm</li> <li>• kg/m</li> <li>• kg/cm</li> <li>• lb/ft</li> <li>• lb/in</li> <li>• oz/ft</li> <li>• oz/in</li> <li>• kPm</li> <li>• dNm</li> </ul>

**Relevant Information**

 Operation types [51]

**How to delete a tool**

1. On the Web User Interface **Navigation menu**, click **Operations**.
2. In the tools list, click **Delete**  next to the tool to delete.
3. In the `Delete tool` confirmation dialog, click **Yes** to confirm.

**How to configure operations**

 Actions and features described in this section might require permissions assigned only to specific user roles. For more information, refer to *User roles and permissions [Page 15]*.

**How to add an operation**

1. On the Web User Interface **Navigation menu**, click **Operations**.
2. In the tools list, select the checkbox of the tool to use for the operation.
3. Below the tools list, click **Next**.
4. On top of the operations list, click **Add Operation**.
5. In the **Define Operation** window, configure the parameters for the new operation. In the lower-right corner of the window, click **Next** and **Back** to navigate the three categories of operation's parameters. For more information, refer to *Operation parameters [Page 36]*.
6. Click **Save**.

**Relevant Information**

 How to run an operation [40]

**How to edit an operation**

1. On the Web User Interface **Navigation menu**, click **Operations**.
2. In the tool list, select the checkbox of the tool linked to the operation to edit, then click **Next**.
3. In the operations list, click **Edit**  next to the operation to edit.
4. In the **Define Operation** window, edit the required parameters. In the lower-right corner of the window, click **Next** and **Back** to navigate the three categories of operation's parameters. For more information, refer to *Operation parameters [Page 36]*.
5. Click **Save**.

**Relevant Information**

 How to run an operation [40]

## Operation

### Operation parameters

#### Controls category

Parameter	Description
<i>Operation name</i>	Assign a name to the operation.
<i>Operation type</i>	This parameter is automatically configured according to the selected <i>Tool type</i> . If the selected <i>Tool type</i> is set to <b>Nutrunner</b> or <b>Peak</b> , it is also possible to set the <i>Operation type</i> to <b>Free Angle</b> .
<i>Check type</i>	The <i>check type</i> defines the requisites for a result to be OK. In the drop-down list, select a check type from the following options: <ul style="list-style-type: none"><li>• <b>Only torque</b>: to have an OK result, the torque value must be within the set limits (regardless of the angle result).</li><li>• <b>Only angle</b>: to have an OK result, the angle value must be within the set limits (regardless of the torque result). This value is available if <i>Tool type</i> is set to <b>Nutrunner</b> or <b>Peak</b>.</li><li>• <b>Torque and angle</b>: to have an OK result, both torque and angle values must be within the set limits. This value is available only if <i>Tool type</i> is set to <b>Nutrunner</b> or <b>Peak</b>.</li></ul>
<i>Test type</i>	In the drop-down list, select a test type from the following options: <ul style="list-style-type: none"><li>• <b>Cm/Cmk</b>.</li><li>• <b>SPC</b>.</li><li>• <b>Manual Adjustment</b>. This value is available only if <i>Tool type</i> is set to <b>Nutrunner</b>.</li><li>• <b>Automatic Adjustment</b>. This value is available only if <i>Tool type</i> is set to <b>Nutrunner</b>.</li></ul> <p><b>i</b> The Automatic Adjustment test type requires an Open Protocol communication with the device.</p>
<i>Direction</i>	In the drop-down list, select the tightening direction from the following options: <ul style="list-style-type: none"><li>• <b>Clockwise</b>.</li><li>• <b>Counterclockwise</b>.</li><li>• <b>Clockwise and counterclockwise</b></li></ul>

#### Parameters category

**i** The availability of parameters depends on the selected operation type.

**i** The dynamic graphic displayed in the category gives a preview of the operation's curve according to the parameters' values.

Parameter	Description	Available with operation types:
<i>Max torque</i>	Type the torque upper limit value to get an OK result.	Click wrench Nutrunner Peak Pulse tool

Parameter	Description	Available with operation types:
<i>Min torque</i>	Type the torque lower limit value to get an OK result.	Click wrench Nutrunner Peak Pulse tool
<i>First threshold</i>	According to the selected <i>Operation type</i> , this threshold is used to detect either the torque peak value or the click point of a wrench.	Click wrench Nutrunner
<i>Second threshold</i>	According to the selected <i>Operation type</i> , this threshold is used to exclude from the analysis the part of the curve below a certain value in order to detect either the proper torque peak or the proper click point.	Click wrench Nutrunner Pulse tool
<i>Max angle</i>	Type the angle upper limit value to get an OK result.	Nutrunner Peak Free angle
<i>Target angle</i>	Type the target angle value for the operation.	Free angle
<i>Min angle</i>	Type the angle lower limit value to get an OK result.	Nutrunner Peak Free angle
<i>Start torque</i>	Type the torque value from which the test starts.	Click wrench Nutrunner Peak Pulse tool
<i>End time</i>	Type the end cycle time. The test ends when the torque drops beneath the <i>Start torque</i> value for a time longer than <i>End time</i> value. For Free Angle strategy, the test ends only after the angle is stable for a time longer than the <i>End time</i> value. Default value: <b>0.1 s</b> . Value range: <b>0.1 - 5 s</b> . For <b>Free Angle</b> strategy, the test ends only after the angle is stable for a time longer than the timer.	Click wrench Nutrunner Peak Pulse tool Free angle
<i>Angle threshold</i>	Type the torque value from which the angle measurement starts.	Nutrunner Peak
<i>Frequency cut</i>	From the drop-down list, select the frequency cut to be applied to the torque samples measured by the WRT.	Click wrench Nutrunner Peak Pulse tool
<i>Max frequency</i>	Type the frequency upper limit value to get an OK result.	Pulse tool
<i>Min frequency</i>	Type the frequency lower limit value to get an OK result.	Pulse tool

## Operation

Parameter	Description	Available with operation types:
<i>Peak monitor</i>	<p>This parameters defines the requisites for a peak to be considered as a result. Select a peak monitor from the following options:</p> <ul style="list-style-type: none"> <li>• <b>Peak Click:</b> the first peak (click point) is considered as result of the test. This value is available only for <b>Click wrench</b> operation type.</li> <li>• <b>Absolute Click:</b> the highest peak (absolute click) is considered as result of the test. This value is available only for <b>Click wrench</b> operation type.</li> <li>• <b>Result at first peak:</b> the first peak detected in the test is considered as result. This value is available only for <b>Nutrunner</b> operation type.</li> <li>• <b>Result at last peak:</b> the last peak detected in the test is considered as result. This value is available only for <b>Nutrunner</b> operation type.</li> </ul>	<p>Click wrench Nutrunner</p>
<i>Angle result at</i>	<p>This parameters defines the method to measure the angle result value. Select one of the following options:</p> <ul style="list-style-type: none"> <li>• <b>Angle result at torque peak:</b> angle result is the angle value measured at torque peak.</li> <li>• <b>Angle result at angle peak:</b> angle result is the angle value measured at angle peak.</li> <li>• <b>Angle result at final angle:</b> angle result is the final angle value.</li> <li>• <b>Angle result at last measured angle:</b> angle result is the angle value measured at the end of the tightening, even if torque value is below the <i>Angle threshold</i> value.</li> </ul>	<p>Nutrunner Peak</p>
<i>Torque factor K</i>	<p>Type the coefficient to correct the torque value read by the WRT in order to match the real torque provided by a Pulse Tool on a joint (residual torque).</p> <p>The value is in thousandth and must be set between 500 and 1000.</p> <p>For more information on how to estimate a proper value for <i>Torque factor K</i>, refer to <i>Pulse Tool [Page 57]</i>.</p>	<p>Pulse tool</p>
<i>Unit</i>	<p>Unit of measurement set for the selected <i>Tool type</i>.</p>	<p>Click wrench Nutrunner Peak Pulse tool</p>

### Statistics category

Parameter	Description	Available with operation types:
<i>Statistics type</i>	<p>In the drop-down list, select the statistics type to be calculated from the following options:</p> <ul style="list-style-type: none"> <li>• <b>ISO (3534-2:2006).</b></li> <li>• <b>Cnomo.</b></li> </ul>	<p>Click wrench Nutrunner Peak Pulse tool Free angle</p>
<i>Batch</i>	<p>Select the checkbox to set the operation as a batch.</p>	<p>Click wrench Nutrunner Peak Pulse tool Free angle</p>

Parameter	Description	Available with operation types:
<i>Batch size</i>	Type the number of times the test must be run in the batch, or use the up- and down-arrow to respectively increase or decrease the value. The maximum value is <b>99</b> . For Free angle strategy <i>Batch size</i> must be between <b>10</b> and <b>30</b> .	Click wrench Nutrunner Peak Pulse tool Free angle
<i>Min Cm (torque)</i>	Type the minimum Cm value for torque measurements to get an OK result.	Click wrench Nutrunner Peak Pulse tool
<i>Min Cmk (torque)</i>	Type the minimum Cmk value for torque measurements to get an OK result.	Click wrench Nutrunner Peak Pulse tool
<i>Min Cm (angle)</i>	Type the minimum Cm value for angle measurements to get an OK result.	Nutrunner Peak Free angle
<i>Min Cmk (angle)</i>	Type the minimum Cmk value for angle measurements to get an OK result.	Nutrunner Peak Free angle

**Relevant Information**

- 📖 Operation types [51]
- 📖 Statistics types [63]
- 📖 Test types [59]

**How to delete an operation**

1. On the Web User Interface **Navigation menu**, click **Operations**.
2. In the tools list, select the checkbox of the tool linked to the operation to delete, then click **Next**.
3. In the operations list, click **Delete**  next to the operation to delete.
4. In the `Delete operation` confirmation dialog, click **Yes** to confirm.

**Operating Instructions**

**How to run a demo test**

1. On the Web user Interface **Navigation menu**, click **Operations**.
2. On the **Operations** page, enable the **Demo mode**.  
For further information, refer to *How to enable/disable the Demo mode [Page 31]*.

3. On the Demo mode menu, select the *Operation type* of interest to expand the category. The available operation types are the following:
  - **Click wrench**
  - **Nutrunner**
  - **Peak**
  - **Pulse tool**
  - **Free angle**
4. In the category of the selected operation type, select the checkbox .
5. In the left panel of the **Operations** page, click **Start Operation** and perform the demo test.
  - ⓘ After clicking **Start Operation**, you are automatically redirected to the **Live Results** page.

For more information on how to edit Demo test parameters, refer to *How to edit a demo test [Page 31]* and to *Demo test parameters [Page 31]*.

## Relevant Information

- 📖 How to navigate Live Results [40]
- 📖 Operation types [51]

## How to run an operation

- ⓘ The operation described in this section requires permissions assigned only to specific user roles. For more information, refer to *User roles and permissions [Page 15]*.
1. On the Web User Interface **Navigation menu**, click **Operations**.
2. In the tools list, select the checkbox of the tool linked to the operation to run. Then, click **Next**.
3. In the operations list, select the operation to run.
4. Click **Start Operation** and perform the test.
  - ⓘ After clicking **Start Operation**, you are automatically redirected to the **Live Results** page.

For more information on how to add or edit operations, refer to *How to add an operation [Page 35]*, *How to edit an operation [Page 35]* and *Operation parameters [Page 36]*.

## Relevant Information

- 📖 How to navigate Live Results [40]
- 📖 Operation types [51]

## How to navigate Live Results

On the Web user Interface **Navigation Menu**, select **Live Results**.

The **Live Results** page provides real time information on the ongoing operation, and it is organized as follows:

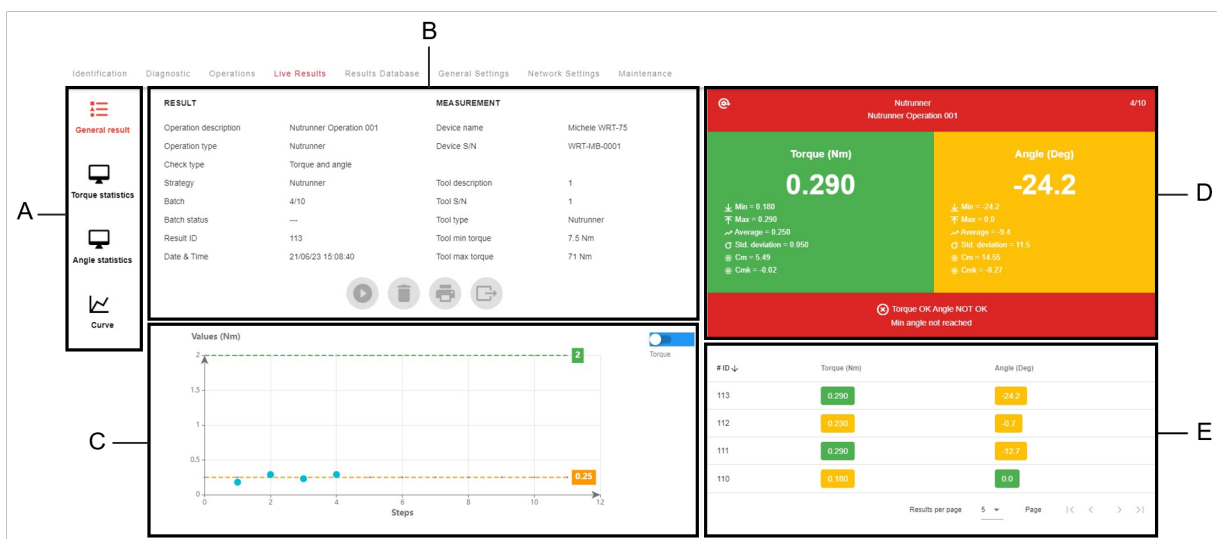

Position	Name	Description
A	Sidebar	Select the tabs on the sidebar to display their respective content: <ul style="list-style-type: none"> <li>• <b>General results</b> - displayed by default in the upper section of the left panel (position B).</li> <li>• <b>Torque statistics</b> - displayed in the upper section of the left panel (position B).</li> <li>• <b>Angle statistics</b> - displayed in the upper section of the left panel (position B).</li> <li>• <b>Curve</b> - displayed in full screen.</li> </ul>
B	Information	The section displays different information depending on the tab selected on the sidebar (position A): <ul style="list-style-type: none"> <li>• <b>General results</b></li> <li>• <b>Torque statistics</b></li> <li>• <b>Angle statistics</b></li> </ul>
C	Control Chart	Control chart of the ongoing operation updated in real time.
D	Result dashboard	Real time overview of the ongoing operation results.
E	Results list	List of the collected results updated in real time.

**i** The **Live Results** page is updated in real time even if a different page of the Web User Interface is open when performing the operation.

**i** During an operation, if network connection is lost and re-established within 2 minutes, the results of tests performed during the connection loss are recovered and displayed on the **Live Results** page.

**General result**

On the Web User Interface **Navigation menu**, select **Live Results**.

The top section of the **Live Results** page's left panel lists the following information:

**Result** category:

<b>Operation description</b>	Name assigned to the operation when created.
<b>Operation type</b>	Type of the ongoing operation.
<b>Check type</b>	Check type defined for the operation when created.
<b>Strategy</b>	Strategy defined for the tool linked to the operation.
<b>Batch</b>	Batch count of the ongoing operation.
<b>Batch status</b>	Batch status according to test results. The batch status can be: <ul style="list-style-type: none"> <li>• NOT OK</li> <li>• OK</li> </ul>
<b>Result ID</b>	Identification number assigned to the single test result by the system.
<b>Date &amp; Time</b>	Date and time of the test result.

**Measurement** category:

<b>Device name</b>	Name assigned to the WRT in use.
<b>Device S/N</b>	Serial number of the WRT in use.
<b>Tool description</b>	Name assigned to the tool under test when configured on the WRT Web User Interface.
<b>Tool S/N</b>	Serial number of the tool under test.
<b>Tool type</b>	Type of tool under test according to the selected strategy.
<b>Tool min torque</b>	Minimum torque of the tool under test.
<b>Tool max torque</b>	Maximum torque of the tool under test.

- i** The **General results** information is displayed by default when opening the **Live Results** page. To select it manually, select **General result** on the sidebar.

### Relevant Information

- ▣ Operation parameters [36]
- ▣ Tool parameters [34]

### Torque statistics

On the Web User Interface **Navigation menu**, select **Live results**.

On the sidebar, select **Torque statistics**.

The top section of the **Live Results** page's left panel displays the **Torque statistics** calculated for the current operation.

- i** Torque Statistics information differs according to the *Statistics type* set for the operation.

**CNOMO** statistics information:

---

<b>Min</b>	Minimum torque value measured in the operation.
<b>Max</b>	Maximum torque value measured in the operation.
<b>Average (X)</b>	Average torque value of the operation results.
<b>Range average</b>	Range average value according to CNOMO standard.
<b>STD (<math>\sigma</math>)</b>	Standard deviation of the results of the operation.
<b><math>3\sigma/X</math> (%)</b>	Value of the “3 sigma percentage” parameter (3 times the standard deviation) over the average value according to CNOMO standard.
<b>X+3<math>\sigma</math></b>	Value of the “average plus 3 times the standard deviation” parameter according to CNOMO standard.
<b>Instantaneous STD (<math>\sigma</math>)</b>	Instantaneous standard deviation of the results of the operation according to CNOMO standard.
<b>Corrected overall STD (<math>\sigma</math>)</b>	Value of the STD ( $\sigma$ ) times the function of the number of samples (C) according to CNOMO standard.
<b>Instantaneous dispersion</b>	Value of 6 times the instantaneous standard deviation.
<b>Tolerance interval</b>	Tolerance interval according to CNOMO normative.
<b>Cm</b>	Calculated Cm.
<b>Cmk</b>	Calculated Cmk.
<b>Homogeneity test</b>	Value of the homogeneity test according to CNOMO normative.

---

**ISO (3534-2:2006)** statistics information:

---

<b>Min</b>	Minimum torque value measured in the operation.
<b>Max</b>	Maximum torque value measured in the operation.
<b>Average</b>	Average torque value of the operation results according to ISO standard.
<b>Range average</b>	Range average value according to ISO standard.
<b>STD (<math>\sigma</math>)</b>	Standard deviation of the results of the operation according to ISO standard.
<b>Tolerance interval</b>	Tolerance interval according to ISO standard.
<b>Cm</b>	Calculated Cm.
<b>Cmk</b>	Calculated Cmk.

---

### Relevant Information

- ▣ CNOMO standard's formulas [63]
- ▣ ISO standard's formulas [65]

### Angle statistics

On the Web User Interface **Navigation menu**, select **Live results**.

On the sidebar, select **Angle statistics**.

The top section of the **Live Results** page's left panel displays the **Angle statistics** calculated for the current operation.

 Angle statistics information differs according to the *Statistics type* set for the operation.

CNOMO statistics information:

<b>Min</b>	Minimum angle value measured in the operation.
<b>Max</b>	Maximum angle value measured in the operation.
<b>Average (X)</b>	Average angle value of the operation results.
<b>Range average</b>	Range average value according to CNOMO standard.
<b>STD (<math>\sigma</math>)</b>	Standard deviation of the results of the operation.
<b><math>3\sigma/X</math> (%)</b>	Value of the “3 sigma percentage” parameter (3 times the standard deviation) over the average value according to CNOMO standard.
<b>X+3<math>\sigma</math></b>	Value of the “average plus 3 times the standard deviation” parameter according to CNOMO standard.
<b>Instantaneous STD (<math>\sigma</math>)</b>	Instantaneous standard deviation of the results of the operation according to CNOMO standard.
<b>Corrected overall STD (<math>\sigma</math>)</b>	Value of the STD ( $\sigma$ ) times the function of the number of samples (C) according to CNOMO standard.
<b>Instantaneous dispersion</b>	Value of 6 times the instantaneous standard deviation.
<b>Tolerance interval</b>	Tolerance interval according to CNOMO standard.
<b>Cm</b>	Calculated Cm.
<b>Cmk</b>	Calculated Cmk.
<b>Homogeneity test</b>	Value of the homogeneity test according to CNOMO standard.

ISO (3534-2:2006) statistics information:

<b>Min</b>	Minimum angle value measured in the operation.
<b>Max</b>	Maximum angle value measured in the operation.
<b>Average</b>	Average angle value of the operation results according to ISO standard.
<b>Range average</b>	Range average value according to ISO standard.
<b>STD (<math>\sigma</math>)</b>	Standard deviation of the results of the operation according to ISO standard.
<b>Tolerance interval</b>	Tolerance interval according to ISO standard.
<b>Cm</b>	Calculated Cm.
<b>Cmk</b>	Calculated Cmk.

**Relevant Information**

-  CNOMO standard's formulas [63]
-  ISO standard's formulas [65]

**How to export statistics report**

After running an operation and completing the batch, it is possible to export the statistics report of the operation.

1. Run the operation until the batch is completed.
2. On the Web User Interface **Navigation menu**, select **Live results**.
3. In the middle of the **Live results** left panel, click **Export**  to save the statistics report locally as .pdf file.

**How to print statistics report**

After running an operation and completing the batch, it is possible to print the statistics report of the operation.

1. Run the operation until the batch is completed.
2. On the Web User Interface **Navigation menu**, select **Live results**.
3. In the middle of the **Live results** left panel, click **Print** .
4. In the print dialog, select the printer to use and configure the settings as applicable. Then, click **Print**.

**Control Chart**

On the Web User Interface **Navigation menu**, select **Live Results**.

## Operation

The bottom section of the **Live Results** page's left panel displays a **Control chart** of the ongoing operation, which is updated in real time:

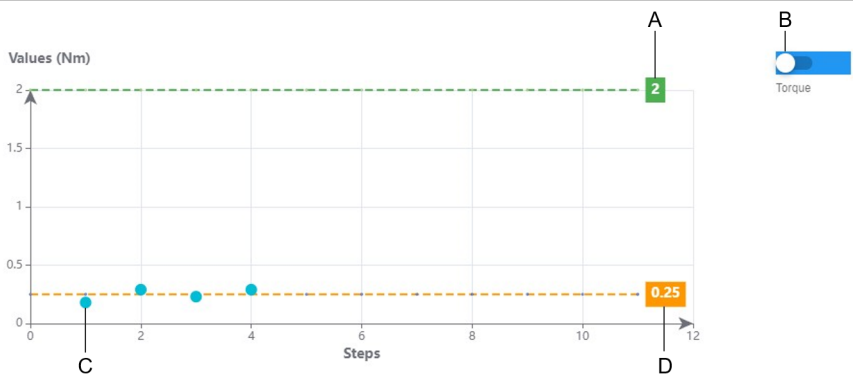

Position	Name	Description
A	Upper limit.	Upper control limit of the monitored values as configured for the operation. For Torque values, upper limit = <i>Max torque</i> . For Angle values, upper limit = <i>Max angle</i> .
B	Value switch.	Switch to select the monitored values. Click the switch to choose between: <ul style="list-style-type: none"> <li>• <b>Torque</b> over steps.</li> <li>• <b>Angle</b> over steps.</li> </ul>
C	Single test results.	Result values of each test in the operation. When performing operations with <i>Test type</i> set to <b>Manual Adjustment</b> , the <b>Control chart</b> also displays black dots that represent the external controller's values that the user enters in the system manually. For more information, refer to <i>How to calibrate a tool with the Manual Adjustment [Page 48]</i> .
D	Lower limit.	Lower control limit of the monitored values as configured for the operation. For Torque values, lower limit = <i>Min torque</i> . For Angle values, lower limit = <i>Min angle</i> .

## Result Dashboard

On the Web User Interface **Navigation menu**, select **Live Results**.

The top section of the **Live Results** page's right panel displays a **Result Dashboard** that provides a real time overview of the ongoing operation results. The dashboard is organized in different areas according to the type of operation ongoing, and to the batch status:

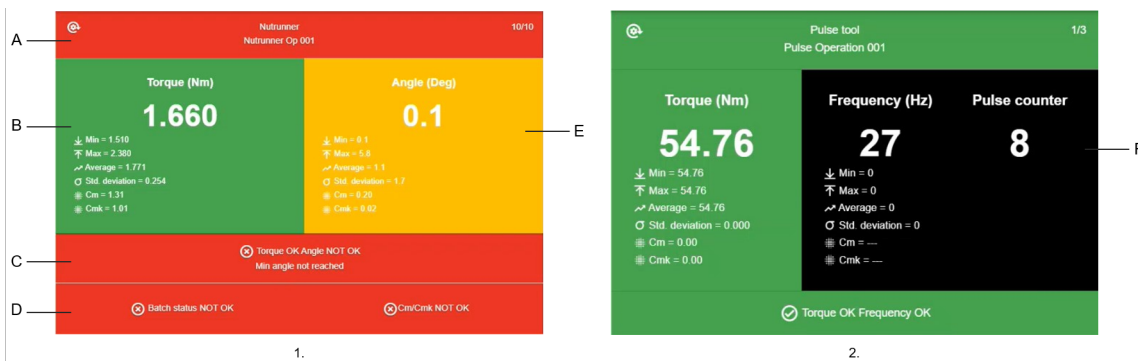

1. Example of Result Dashboard for a Nutrunner operation with batch complete.
2. Example of Result Dashboard for a Pulse tool operation with batch incomplete.

Position	Name	Description
A	Operation result	<p>Color of the area indicates the result of the operation based on the tests run so far:</p> <ul style="list-style-type: none"> <li>• Green: overall operation result is OK.</li> <li>• Red: overall operation result is Not OK.</li> </ul>
B	Torque result	<p>Color of the area indicates the torque result of the single test:</p> <ul style="list-style-type: none"> <li>• Green: torque value is within the upper and lower limits; Torque is OK.</li> <li>• Red: torque value exceeds the upper limit; Torque is Not OK.</li> <li>• Yellow: torque value is below the lower limit; Torque is Not OK.</li> </ul> <p>If <i>Check type</i> is set to <b>Only angle</b>, the area is gray.</p>
C	Single test result	<p>Color of the area indicates the result of the single test:</p> <ul style="list-style-type: none"> <li>• Green: overall operation result is OK.</li> <li>• Red: overall operation result is Not OK.</li> </ul>
D	Batch result	<p>Color of the area indicates the result of the batch:</p> <ul style="list-style-type: none"> <li>• Green: batch result is OK.</li> <li>• Red: batch result is Not OK.</li> </ul> <p>The area is available only after completing the batch.</p> <p>When performing operations with <i>Test type</i> set to <b>Manual Adjustment</b>, this area displays the calibration result and the new calibration value. For more information, refer to <i>How to calibrate a tool with the Manual Adjustment [Page 48]</i>.</p>
E	Angle result	<p>Color of the area indicates the angle result of the a single test:</p> <ul style="list-style-type: none"> <li>• Green: angle value is within the upper and lower limits; Angle is OK.</li> <li>• Red: angle value exceeds the upper limit; Angle is Not OK.</li> <li>• Yellow: angle value is below the lower limit; Angle is Not OK.</li> </ul> <p>If <i>Check type</i> is set to <b>Only torque</b>, the area is gray.</p>
F	Pulse tool data	<p>The area is available only if <i>Operation type</i> is set to <b>Pulse tool</b>.</p> <p>The area is always black.</p>

Each area provides information as follows:

Area	Information
Operation result	<ul style="list-style-type: none"> <li>• Operation type</li> <li>• Operation description</li> <li>• Batch count</li> </ul>
Torque result	<ul style="list-style-type: none"> <li>• Torque value measured during the test.</li> <li>• Minimum torque value measured in the operation so far.</li> <li>• Maximum torque value measured in the operation so far.</li> <li>• Average torque value measured in the operation so far.</li> <li>• Standard deviation calculated for the operation so far.</li> <li>• Cm calculated for the operation so far.</li> <li>• Cmk calculated for the operation so far.</li> </ul>

Area	Information
Angle result	<ul style="list-style-type: none"> <li>• Angle value measured during the test.</li> <li>• Minimum angle value measured in the operation so far.</li> <li>• Maximum angle value measured in the operation so far.</li> <li>• Average angle value measured in the operation so far.</li> <li>• Standard deviation calculated for the operation so far.</li> <li>• Cm calculated for the operation so far.</li> <li>• Cmk calculated for the operation so far.</li> </ul>
Single test result	<ul style="list-style-type: none"> <li>• The torque and/or angle result(s) for the single test, depending on the <i>Check type</i> set for the operation.</li> <li>• Brief explanation of the result.</li> </ul>
Batch result	<ul style="list-style-type: none"> <li>• Batch result.</li> <li>• Result according to statistics type.</li> </ul> <p>If the operation has <i>Test type</i> set to <b>Manual Adjustment</b>:</p> <ul style="list-style-type: none"> <li>• Calibration result.</li> <li>• New calibration value.</li> </ul>
Pulse tool data	<ul style="list-style-type: none"> <li>• Frequency measured during the test.</li> <li>• Number of pulses recorded during the test.</li> <li>• Minimum frequency value measured in the operation so far.</li> <li>• Maximum frequency value measured in the operation so far.</li> <li>• Average frequency value measured in the operation so far.</li> <li>• Standard deviation calculated for the operation so far.</li> <li>• Cm calculated for the operation so far.</li> <li>• Cmk calculated for the operation so far.</li> </ul>

### Results List

On the Web User Interface **Navigation menu**, select **Live Results**.

The bottom section of the **Live Results** page's right panel lists the result values acquired during the operation.

The list is organized in the following columns:

- **#ID**: results identification number.  
The result ID is automatically assigned by the system.
- **Torque**: torque measured value.  
This column is available only for operations with *Check type* set to **Only torque** or **Torque and Angle**.
- **Angle**: angle measured value.  
This column is available only for operations with *Check type* set to **Only angle** or **Torque and Angle**.
- **System torque**: torque value taken from an external controller and manually entered by the user.  
This column is available only for operations with *Test type* set to **Manual Adjustment**.
- **Frequency**: measured frequency of the pulse tool under test.  
This column is available only for operations with *Operation type* set to **Pulse tools**

The torque and angle results values are marked with colors according to how the values are positioned in relation to the upper and lower limits set for the operation:

- Green: result value is within the upper and lower limits values.
- Red: result value is over the upper limit value.
- Yellow: result value is below the lower limit value.

Below the results list, select a number in the **Results for page** drop-down list to set the number of results to be displayed per page.

To navigate a results list that takes more pages, use the navigation buttons **First page** |<, **Previous** <, **Next** >, and **Last page** >|.

**Curve**

On the **Navigation menu**, click **Live Results**.

On the sidebar, select **Curve** to open a page showing in real time the curves acquired during the ongoing tests.

- ❶ If a new test starts before the curve data transfer is completed, the data transfer of the first curve is interrupted in order to start the data transfer of the new curve.

On the left of the curve, select **Parameters** and expand the categories to view the following information:

**General category**

---

<b>Device type</b>	Connected device type.
<b>Operation description</b>	Name assigned to the operation when created.
<b>Strategy</b>	Strategy defined for the operation.
<b>Unit</b>	Unit of measurement set for the tool.
<b>Transducer type</b>	Type of transducer used for the operation
<b>Serial number</b>	Serial number of the connected device.
<b>Date Time</b>	Date and time when the test has been run.
<b>Identification</b>	Test identification number automatically generated by the system.
<b>Status</b>	Test result: <ul style="list-style-type: none"> <li>• OK</li> <li>• Not OK</li> </ul>

---

**Angle category**

---

<b>Angle status</b>	Test angle result: <ul style="list-style-type: none"> <li>• Report ok</li> <li>• Report not ok</li> </ul>
<b>Angle result time</b>	Time taken to acquire the angle result.
<b>Angle result at</b>	Torque value at which the angle value for the result is taken.
<b>Angle result</b>	Angle result value.
<b>Angle peak</b>	Detected angle peak.
<b>Min angle</b>	Lower limit angle value to get an OK result.
<b>Max angle</b>	Upper limit angle value to get an OK result.

---

**Torque category**

---

<b>Torque status</b>	Test torque result: <ul style="list-style-type: none"> <li>• Report ok</li> <li>• Report not ok</li> </ul>
<b>Torque result time</b>	Time taken to acquire the torque result.
<b>Torque result</b>	Torque result value.
<b>Torque peak</b>	Detected torque peak.
<b>Peak</b>	Requisite for a peak to be considered as a result.
<b>Start torque</b>	Torque value from which the test started.
<b>Angle threshold</b>	Torque value from which the angle measurement started.
<b>Min torque</b>	Lower limit torque value to get an OK result.
<b>Max torque</b>	Upper limit torque value to get an OK result.

---

**Relevant Information**

- 📖 Tool parameters [34]
- 📖 Operation parameters [36]

## Operation

How to configure the curve view

On the **Curve** page, select **Options** and expand the categories to configure the curve view:

---

<b>Curve type</b>	Select one checkbox to choose which type of curve to display: <ul style="list-style-type: none"><li>• <b>Torque/Time</b></li><li>• <b>Torque/Angle</b></li><li>• <b>Angle/Time</b></li><li>• <b>Torque/Angle/Time</b></li></ul>
<b>Results</b>	Select one or more checkboxes to choose which acquired values to display in the curve: <ul style="list-style-type: none"><li>• <b>Torque Result</b> (represented with a blue circle in the curve)</li><li>• <b>Torque Peak</b> (represented with a blue triangle in the curve)</li><li>• <b>Angle Result</b> (represented with a yellow circle in the curve)</li><li>• <b>Angle Peak</b> (represented with a yellow triangle in the curve)</li></ul>
<b>Limits</b>	Select one or more checkboxes to choose which control limits to display in the curve: <ul style="list-style-type: none"><li>• <b>Torque Max</b> (represented with a blue line in the curve)</li><li>• <b>Torque Min</b> (represented with a blue line in the curve)</li><li>• <b>Angle Max</b> (represented with a yellow line in the curve)</li><li>• <b>Angle Min</b> (represented with a yellow line in the curve)</li></ul>

---

### How to calibrate a tool with the Manual Adjustment

**i** The operation described in this section requires permissions assigned only to specific user roles. For more information, refer to *User roles and permissions [Page 15]*.

**i** This operation is available only if *Operation type* is set to **Nutrunner**.

1. Connect the tool to calibrate to an external controller (e.g. CVI 3).
2. On the Web User Interface **Navigation menu**, click **Operations**.
3. In the tools list, select the checkbox of the tool to calibrate. Then, click **Next**.
4. Click **Add operation**. In the **Define Operation** window, set *Test type* to **Manual Adjustment** and configure the remaining parameters as required.  
For more information refer to *Operation parameters [Page 36]*.

**i** For operations with *Test type* set to **Manual Adjustment**, the available *Check types* are **Only torque** (default) and **Torque and Angle**.

In the **Statistics** category of the operation parameters, the only available parameter is *Batch size*.

5. Click **Start Operation**. You are automatically redirected to the **Live Results** page.

**i** Before starting the operation, take note of the *Initial calibration value* and of the *Current calibration value* displayed on the external controller's screen. You will be asked to provide them at the end of the calibration procedure.

6. Select a suitable Pset on the external controller.
7. Perform a tightening.

In the **Results List**, under the **System Torque** column click **Edit**  in the row of the result you just collected, and enter the torque value displayed on the external controller screen. Then, press Enter on your keyboard to confirm.



Repeat this step for each tightening you perform, until the batch is completed.

8. Once the batch is completed, in the left panel of the **Live Results** page click **Calculate** .  
In the dialog, enter the *Initial calibration value* and the *Current calibration value* that were displayed on the external controller screen at the beginning of the procedure, then click **OK**.  
In the right panel of the **Live Results** page, the new calibration value is displayed in the bottom area of the **Results dashboard**.

9. If the new calibration value is OK, enter the new calibration value manually in the external controller.

To start a new calibration operation with the same configuration, click **Start/Pause**  in the left panel of the **Live Results** page.

**Relevant Information**

-  How to edit an operation [35]
-  How to add an operation [35]
-  How to navigate Live Results [40]

**How to export a calibration report**

After completing a calibration operation, it is possible to export the calibration report.

1. Complete the calibration operation to have a new calibration value.
2. On the Web User Interface **Navigation menu**, select **Live results**.
3. In the middle of the **Live results** left panel, click **Export**  to save the calibration report locally as .pdf file.

**How to print a calibration report**

After completing a calibration operation, it is possible to print the calibration report.

1. Complete the calibration operation to have a new calibration value.
2. On the Web User Interface **Navigation menu**, select **Live results**.
3. In the middle of the **Live results** left panel, click **Print** .
4. In the print dialog, select the printer to use and configure the settings as applicable. Then, click **Print**.

**How to navigate Results Database**

The WRT can store up to 50000 results. After the 50000th result, each new collected result overwrites the oldest one stored in the device.

To view the details of all results stored in the device, select **Results Database** on the Web user Interface **Navigation Menu**.



The results list is organized in several columns showing different details. It is possible to sort the list according to a specific item by clicking the arrow in the header of the relevant column.

To view all columns in the **Results Database**, use the horizontal scrollbar at the bottom of the page.









To navigate the **Results Database** pages, in the lower-right corner of the page use the navigation buttons **First Page** |<, **Previous** <, **Next** > and **Last Page** >|.

In the lower-right corner of the page, select how many results to show per page in the drop-down list.

The main columns that define the results list are the following:

Name	Description
<b>Result ID</b>	Progressive ID number assigned by the system to each test result. The result ID label also shows the result status <ul style="list-style-type: none"> <li>• If green with the OK icon , the results is ok according to the operation configuration.</li> <li>• If red with the NOK icon , the result is not ok according to the operation configuration.</li> </ul>
<b>Curve</b>	Click <b>View curve</b>  to open the result curve window.
<b>Date</b>	Date and time when the results has been collected.
<b>Operation ID</b>	ID number of the operation in which the result has been collected.

## Operation

Name	Description
<b>Operation description</b>	Name assigned to the operation in which the result has been collected.
<b>Strategy</b>	Strategy assigned to the tool used to run the test.
<b>Check type</b>	Check type of the operation in which the result has been collected.
<b>Test type</b>	Test type of the operation in which the result has been collected.
<b>Torque</b>	<p>Torque result value.</p> <p>The value label also indicate the torque result status:</p> <ul style="list-style-type: none"><li>• If green with the OK icon , the torque result value is ok according to the operation configuration.</li><li>• If red with the Up-Arrow icon , the torque result value is above the upper torque limit set for the operation.</li><li>• If yellow with the Down-Arrow icon , the torque result value is below the lower torque limit set for the operation.</li><li>• If grey, the operation <i>Check type</i> is <b>Only angle</b>.</li></ul>
<b>Angle</b>	<p>Angle result value.</p> <p>The value label also indicate the angle result status:</p> <ul style="list-style-type: none"><li>• If green with the OK icon , the angle result value is ok according to the operation configuration.</li><li>• If red with the Up-Arrow icon , the angle result value is above the upper angle limit set for the operation.</li><li>• If yellow with the Down-Arrow icon , the angle result value is below the lower angle limit set for the operation.</li><li>• If grey, the operation <i>Check type</i> is <b>Only torque</b>.</li></ul>
<b>Batch status</b>	<p>Result of the batch in which the result has been collected:</p> <ul style="list-style-type: none"><li>• If the label is green with the OK icon , batch result is ok.</li><li>• If the label is red with the NOK icon , batch result is not ok.</li><li>• If the field is empty: batch incomplete.</li></ul>
<b>Result details</b>	Brief explanation of the result.

### How to download stored results

1. On the Web User Interface **Navigation menu**, select **Results Database**.
2. In the upper-right corner of the page, click **Download** .
3. In the `Separators` dialog, select from the drop-down list a separator for the `csv` format.
4. Click **Confirm**.

### How to print stored results

1. On the Web User Interface **Navigation menu**, select **Results Database**.
2. In the upper-right corner of the page, click **Print** .
3. In the print dialog, select the printer to use and configure the settings as applicable. Then, click **Print**.

**References**

**Operation types**

**Click Wrench**

A Click Wrench operation detects the click point of the wrench.

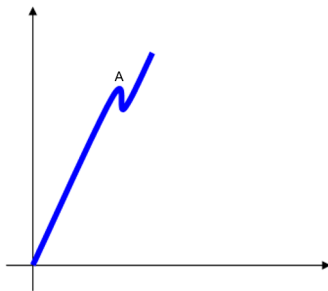

Illustration 4: Torque vs. Time

---

A Click Point

---

The click point is detected when the torque drops down and then increases again, producing a curve with the typical shape of the “click phenomenon”:

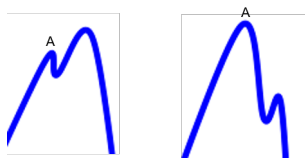

Illustration 5: Torque vs. Time

---

A Click Point

---

If the torque drops down to zero and does not increase again after a peak point, the click point is not detected:

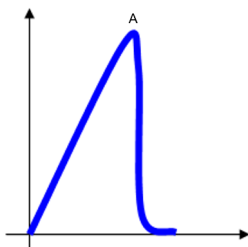

Illustration 6: Torque vs. Time

---

A Point not detected as click point

---

**i** The default *Filter frequency* for Click Wrench test is **100 Hz**.

The parameters that characterize the click point detection are the following:

- *End time*: timer that determines the end of a test. After detecting the peak value, if the torque decreases and remains below the transducer minimum load value (usually 10% of the transducer full scale) for a time equal or longer than the *End time* value, the test ends.

The *End time* value range is 0.1 - 5 s; the default value is 0.1 s.

## Operation

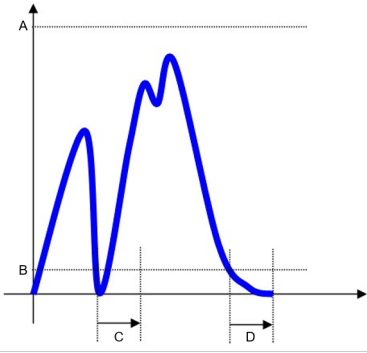

Illustration 7: Torque vs. Time

A	Transducer full scale	C	End time
B	Transducer min load	D	End time

- *1st threshold*: threshold used to detect the click point. For a peak to be considered a click point, the torque value must continuously decrease from the measured peak at least till the *1st threshold* value. If the torque value starts increasing again before reaching the *1st threshold* value, the peak is not considered a click point.

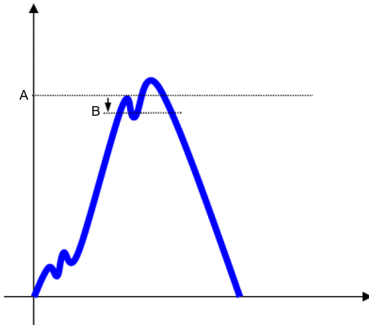
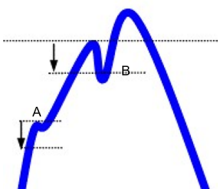

Illustration 8: Torque vs. Time

A	Click point	B	1st threshold
---	-------------	---	---------------

The *1st threshold* default value is **2%** of the relative torque peak value reached during the test.

Depending on the wrench under test, it may be necessary to adjust the *1st threshold*. For example, if the click point produces a big drop in the torque value, the *1st threshold* value could be increased, in order to avoid detecting false click points at lower torque values:



A	False click point: not detected	B	1st threshold that could be increased to avoid detecting a false click point.
---	---------------------------------	---	---

On the other side, if the click point produces only a little drop in the torque value, the *1st threshold* should be decreased in order to detect the click point.

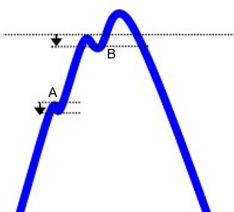

A	False click that could be detected as click point	B	1st threshold that could be decreased to make sure to detect the real click point.
---	---	---	--

i) Setting the *1st threshold* value too low increases the risk of detecting false click points, while setting this value too high increases the risk of not detecting the real click point. The best trade-off can be figured out only looking at the characteristics of the specific click wrench under test.

- *2nd threshold*: threshold used to exclude noise that might interfere with the click detection. Torque values below the *2nd threshold* are not taken into account in order to avoid detecting false click points that may occur if the operator movement is not steady enough.

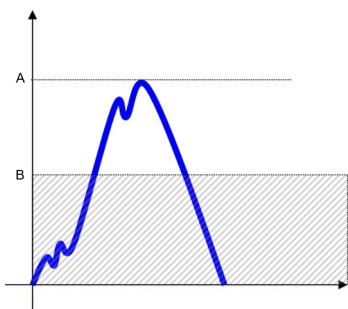

Illustration 9: Torque vs. Time

A	Max torque	B	2nd threshold
---	------------	---	---------------

The whole *Click Phenomenon*, including the point when the torque value starts increasing again, must be above *2nd threshold*. If not, the click point is not detected.

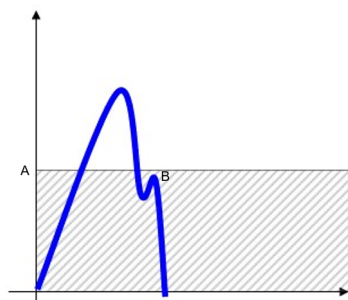

Illustration 10: Torque vs. Time

A	2nd threshold	B	The point in which the torque value starts increasing again is below the 2nd threshold: click point not detected
---	---------------	---	--

The *2nd threshold* default value is **30%** of the maximum torque value reached during the test.

- *Peak monitor*: Method to define which peak must be considered as result. The available options are the following:
  - **Peak Click**: the first peak (click point) is considered as result of the test.
  - **Absolute Click**: the highest peak (absolute click) is considered as result of the test.

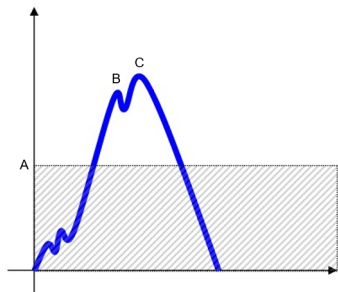

Illustration 11: Torque vs. Time

A	2nd threshold	B	Point considered as result if <i>Peak monitor</i> is set to <b>Peak Click</b> .
C	Point considered as result if <i>Peak monitor</i> is set to <b>Absolute Click</b> .		

# Operation

## Relevant Information

- 📖 CNOMO standard's formulas [63]
- 📖 ISO standard's formulas [65]

## Peak

A Peak operation detects the maximum torque measured during a test.

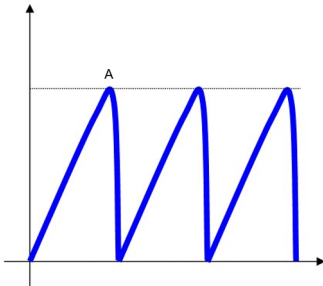

Illustration 12: Torque vs. Time

---

A	Peak
---	------

---

❗ The default *Filter frequency* for Peak operations is **100 Hz**.

The *End time* value determines the end of a test: after detecting the peak value, if the torque decreases and remains below the transducer minimum load value (usually 10% of the transducer full scale) for a time equal or longer than the *End time* value, the test ends.

The *End time* value range is 0.1 - 5 s; the default value is 0.1 s.

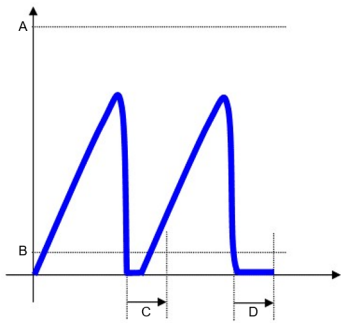

Illustration 13: Torque vs. Time

---

A	Transducer full scale	B	Transducer min load
C	End time	D	End time

---

When working with slip wrenches, the operator should stop operating the wrench once the peak (slip point) is reached.

If the operator keeps on rotating the wrench and the *End time* value is low, more than one peak point is produced. In this case only the absolute peak is considered the test result. If a second peak point is produced and is similar to the first one, the first peak is considered as absolute peak.

## Nutrunner

A Nutrunner operation detects the peak torque during a test performed on nutrunners, meant as tools that apply a real torque on a joint.

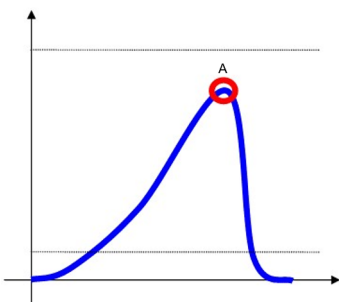

Illustration 14: Torque vs. Time

A Peak torque

**i** The default *Filter frequency* for Nutrunner operations is **500 Hz**.

In case of multiple peaks, the result depends on the configuration of the operation.

The parameters that characterize the peak detection are the following:

- *End time*: timer that determines the end of a test. After detecting the peak value, if the torque decreases and remains below the transducer minimum load value (usually 10% of the transducer full scale) for a time equal or longer than the *End time* value, the test ends.

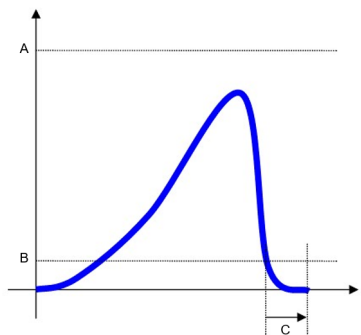

Illustration 15: Torque vs. Time

A Transducer full scale  
C End time

B Transducer min load

For two-steps tools, the *End time* allows the tool to switch between the two steps without ending the test.

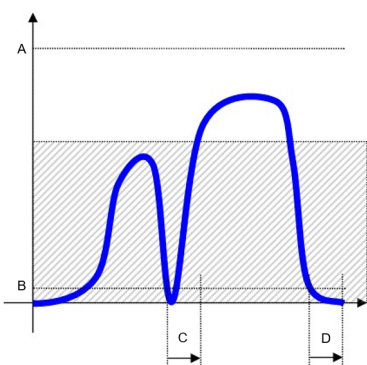

Illustration 16: Torque vs. Time

A Transducer full scale  
C End time

B Transducer min load  
D End time

The *End time* value range is 0.1 - 5 s; the default value is 0.1 s.

- *Peak monitor*: Method to define which peak must be considered as result. The available options are the following:
  - **First Peak**: the highest peak (first peak) is considered as result of the test.
  - **Last Peak**: the last peak is considered as result of the test.
- *1st threshold* and *2nd threshold*: depending on the value set for *Peak monitor*, the thresholds have different applications:
  - With **First Peak** as *Peak monitor*, *1st threshold* and *2nd threshold* serve to detect the peak point.

For a peak to be considered the result for the test, the torque value must continuously decrease from the measured peak at least till the *1st threshold* value. If the torque value starts increasing again before reaching the *1st threshold* value, the peak is not considered a click point. Meanwhile, all torque values below the *2nd threshold* are not taken into account in order to exclude noise that might interfere with the peak detection. If the peak is below the *2nd threshold*, it is not detected.

The *1st threshold* default value is **5%** of the relative torque peak value reached during the test.

The *2nd threshold* default value is **90%** of the maximum torque value reached during the test.

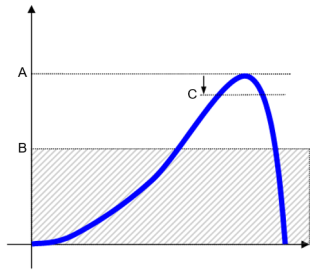

Illustration 17: Torque vs. Time

A	Peak torque	B	2nd threshold
C	1st threshold		

For two-step nutrunners, the *2nd threshold* serves also to exclude the first step from the analysis. If not set properly, the peak of the first step is considered as result.

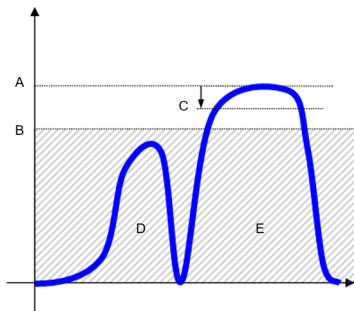

Illustration 18: Torque vs. Time

A	Peak torque	B	2nd threshold
C	1st threshold	D	First step
E	Second step		

- With **Last Peak** as *Peak monitor*, *1st threshold* and *2nd threshold* serves to detect the last peak as test result, even if this is lower than the maximum peak.

A typical scenario for this configuration is the search of the last torque in self-tapping or special screws, where the last torque peak is considered the torque applied to the joint.

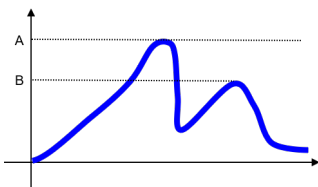

Illustration 19: Torque vs. Time

A	Highest peak	B	Result (last peak)
---	--------------	---	--------------------

In this case, the *1st threshold* serves to detect the torque result (last peak). To consider the last peak as result, the torque value **before** the last peak must continuously decrease from the measured peak at least till the *1st threshold* value. If the torque value starts increasing again before reaching the *1st threshold* value, the last peak is not considered a click point. Meanwhile, all torque values below the *2nd threshold* are not taken into account in order to exclude noise that might interfere with the peak detection. If the last peak is below the *2nd threshold*, it is not detected.

The *1st threshold* default value is **10%** of the relative torque peak value reached during the test.

The *2nd threshold* default value is **50%** of the maximum torque value reached during the test.

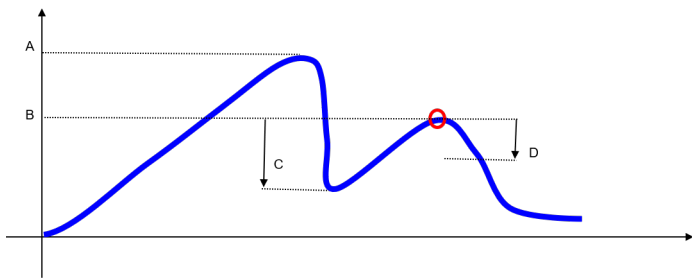

Illustration 20: Torque vs. Time

A	Peak torque	B	Result (last peak)
C	Torque drop before last peak	D	1st threshold

**Pulse Tool**

A Pulse Tool operation detects the peak torque value measured during a test on a pulse tool.

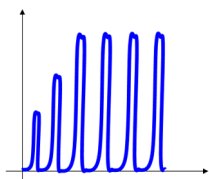

Illustration 21: Torque vs. Time

**i** The default *Filter frequency* for Pulse Tool operations is **2000 Hz**.

The parameters that characterize the peak point detection are the following:

*End time*: timer that determines the end of a test. After detecting the peak value, if the torque decreases and remains below the transducer minimum load value (usually 10% of the transducer full scale) for a time equal or longer than the *End time* value, the test ends.

The *End time* value range is 0.1 - 5 s; the default value is 0.1 s.

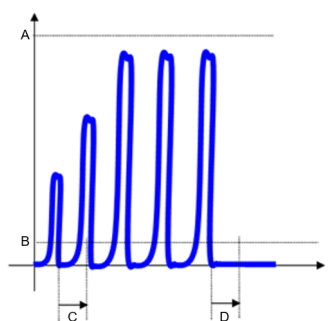

Illustration 22: Torque vs. Time

A	Transducer full scale	B	Transducer min load
C	End time	D	End time

- *2nd threshold*: threshold used to exclude noise that might interfere with the peak detection. For each peak, torque values below the *2nd threshold* are not taken into account in order to filters all the bounces that characterize pulse tightenings.

The *2nd threshold* default value is **80%** of the maximum torque value reached during the test.

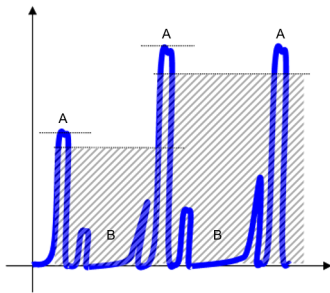

Illustration 23: Torque vs. Time

A	Peak torque	B	Bounces
---	-------------	---	---------

- *Torque factor K*: coefficient used to adjust the torque measured by the transducer to match the real torque generated on a joint by a pulse tool.

Pulse tools do not provide a continuous torque output, instead they generate a single high energy pulse with a very short duration ( $\approx 1\text{ms}$ ). This set of pulses results in the tightening of a fastener.

The final torque cannot be measured directly (as for real torque tools), due to the physical characteristics of the pulse tools: pulse tools apply a very high torque for such a short time that only a part of the torque peaks is translated into the tightening of the fastener (generating more clamping force). The actual torque that is generated on the joint is affected by different factors - such as the bolt mass, friction, the stiffness of the joint - and is normally lower than the peak torque measured by a transducer.

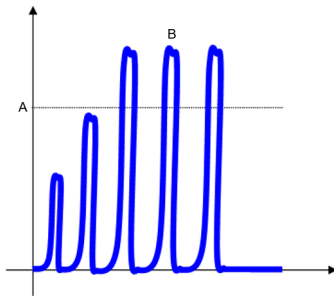

Illustration 24: Torque vs. Time

A	Actual torque generated on the joint	2	Peak value measured by the transducer
---	--------------------------------------	---	---------------------------------------

The torque coefficient *Torque factor K* makes it possible to adjust the torque value measured by a transducer in order to make it match the actual torque value generated on the joint. *Torque factor K* can be set to values between 100 and 10000, and it is entered in thousandths, meaning that 500 corresponds to 0.500 and 1000 correspond to 1.000.

To calculate the proper *Torque factor K* value for a pulse tool, it is necessary to measure the actual torque generated on the joint by running a residual torque check on the real joint.

To calculate the proper coefficient *Torque factor K* for a pulse tool, do the following:

1. Apply a low torque to the joint with the pulse tool.
2. Check the residual torque on the joint.
3. If the residual torque is the same of the torque applied, apply the same torque with the same tool to the transducer.
4. Calculate the coefficient as follows:

$$\text{Torque factor } K = \text{Actual torque generated on the joint} / \text{torque measured by the transducer}$$

For instance, consider a target torque for the joint equal to 100 Nm. Once the tool adjustment is made, the residual torque check is equal to 100 Nm. If the torque measured on the transducer is equal to 120 Nm, the coefficient *K* corresponds to  $100/120 = 0.83$ ; due to the fact that the value is entered in thousandths, the coefficient *K* is equal to 830.

- ⓘ The relation between the peak torque measured by the transducer and the actual torque generated on the joint is affected by all the components involved in the operations: the pulse tool, the adapters, the transducer and the joint itself. If any of these components changes, the relation between the actual torque and the peak torque must be recalculated according to the changes.

### Free Angle

A Free Angle operation measures the angle value while monitoring it stays within the tolerance limits set for the operation.

The parameters that characterize tests with Free angle strategy are the following:

- *Max angle*: angle upper limit value to get an OK result.
- *Min angle*: angle lower limit value to get an OK result.
- *Min Cm (angle)*: minimum Cm value for angle measurements to get an OK result.
- *Min Cmk (angle)*: minimum Cmk value for angle measurements to get an OK result.

When running a Free Angle operation batch, follow the instructions below:

1. Select and start the Free Angle operation as instructed in section *How to run an operation [Page 40]*.
2. Run the test until the Status LED on the WRT interface starts blinking green.
3. On the WRT interface, press the ON/OFF button once. Then, run the next test in the batch.
4. Repeat point 2. and 3. until the batch is completed.

### Relevant Information

- ▣ User interface [9]
- ▣ LED system [10]

### Test types

#### SPC test

The SPC (Statistical Process Control) test assesses tool's performances by analyzing the tool's results trends in relation to a set of control limits, according to a series of standard rules.

With an SPC test, a pre-defined number of results values is collected in subgroups in order to determine the average of each subgroup. The averages' trend is then analyzed to monitor its behavior in relation to the set limits, and to verify whether the SPC rules are met or not.

The test makes it possible to get a trend of the tool's performances and to take action to correct anomalies or critical behaviors.

#### SPC test limits

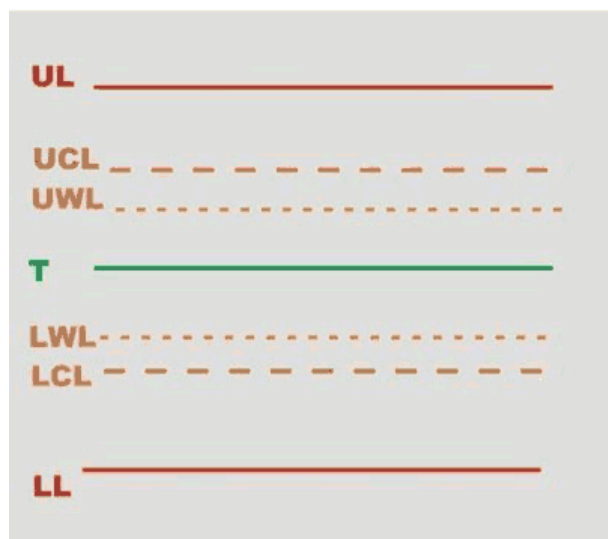

UL	Upper Limit	LWL	Lower Warning Limit
UCL	Upper Control Limit	LCL	Lower Control Limit
UWL	Upper Warning Limit	LL	Lower Limit
T	Target (nominal)		

Upper Limit (UL) and Lower Limit (LL) are the limits the user configures for the test.

## Operation

The other SPC test limits are calculated as follows:

$$\text{Upper Control Limit} \quad UCL = \frac{UL + LL}{2} + A \frac{UL - LL}{6}$$

$$\text{Lower Control Limit} \quad LCL = \frac{UL + LL}{2} - A \frac{UL - LL}{6}$$

$$\text{Upper Warning Limit} \quad UWL = \frac{UL + LL}{2} + \frac{2}{3} \times \left( UCL - \frac{UL + LL}{2} \right)$$

$$\text{Lower Warning Limit} \quad LWL = \frac{UL + LL}{2} - \frac{2}{3} \times \left( \frac{UL + LL}{2} - LCL \right)$$

$$\text{Range} \quad Range = D_2 \frac{UL - LL}{6}$$

In these formulas,  $A$  and  $D_2$  are coefficients that depend on the number of SPC tests performed:

Number of SPC tests	A	D2
1	0.000	0.000
2	2.121	3.686
3	1.732	4.358
4	1.500	4.698
5	1.342	4.918
6	1.225	5.078
7	1.134	5.204
8	1.061	5.306
9	1.000	5.393
10	0.949	5.469
11	0.905	5.535
12	0.866	5.594
13	0.832	5.647
14	0.802	5.696
15	0.775	5.741
16	0.750	5.782
17	0.728	5.820
18	0.707	5.856
19	0.688	5.891
20	0.671	5.921
21	0.655	5.951
22	0.640	5.979
23	0.626	6.006
24	0.612	6.031
25	0.600	6.056

### SPC test rules

Rules applied to the set of tests performed in a single SPC test.

- **Last average is out of control limits**

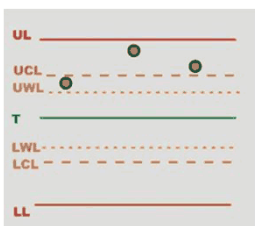

**Tool usability:** Tool can be used.

**Diagnosis:** The average is higher than the upper control limit, but it does not exceed the upper tolerance limit.

**Further actions:** Calibrate decreasing the torque.

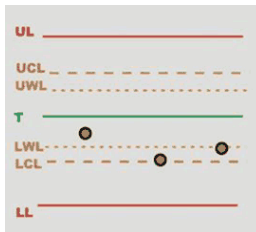

**Tool usability:** Tool can be used.

**Diagnosis:** The average is lower than the lower control limit, but it does not fall under the lower tolerance limit.

**Further actions:** Calibrate increasing the torque.

• **Dispersion is too large**

**i** Dispersion is considered too large when the difference between the maximum and minimum value is greater than the Range (see Range formula above).

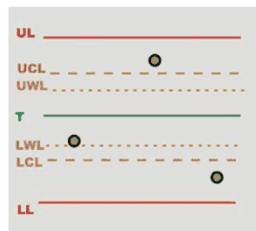

**Tool usability:** Tool can be used

**Diagnosis:** Excessive dispersion of the values prevents a proper calibration of the tool, but the measured values are still within the tolerance limits.

**Further actions:** Repair.

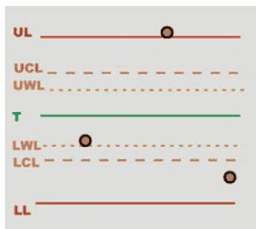

**Tool usability:** Tool **cannot** be used

**Diagnosis:** Some measured values are out of tolerance limits. Excessive dispersion of the values prevents a proper calibration of the tool.

**Further actions:** Remove the tool from the production line and repair.

• **At least one value is outside the tolerance limits**

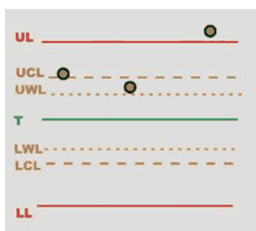

**Tool usability:** Tool **cannot** be used.

**Diagnosis:** At least one value is higher than the upper tolerance limit.

**Further actions:** Remove the tool from the production line and calibrate decreasing the torque.

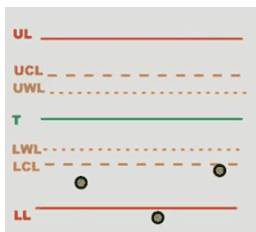

**Tool usability:** Tool **cannot** be used.

**Diagnosis:** At least one value is lower than the lower tolerance limit.

**Further actions:** Remove the tool from the production line and calibrate increasing the torque

Rules applied to the last averages of the set of tests performed in consequential statistical control tests:

• **Last 7 averages are over or under the nominal value**

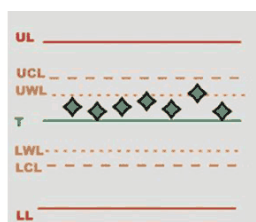

**Tool usability:** Tool can be used.

**Diagnosis:** Averages are higher than the target value, but they do not exceed the upper tolerance limit.

**Further actions:** Further actions: Calibrate decreasing the torque.

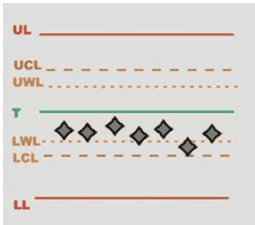

**Tool usability:** Tool can be used.

**Diagnosis:** Averages are lower than the target value, but they do not fall under the lower tolerance limit.

**Further actions:** Calibrate increasing the torque.

• Last 7 averages are increasing or decreasing

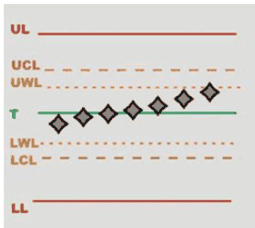

**Tool usability:** Tool can be used.

**Diagnosis:** Averages tend to be higher than the target value, but they do not exceed the upper tolerance limit.

**Further actions:** Calibrate decreasing the torque.

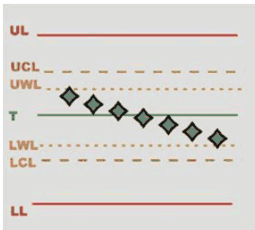

**Tool usability:** Tool can be used.

**Diagnosis:** Averages tend to be lower than the target value, but they do not fall under the lower tolerance limit.

**Further actions:** Calibrate increasing the torque.

• Last 2 averages out of the warning limits

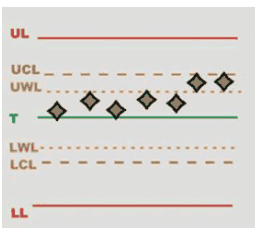

**Tool usability:** Tool can be used.

**Diagnosis:** Averages are higher than the Upper Warning Limit, but they do not exceed the upper tolerance limit.

**Further actions:** Calibrate decreasing the torque.

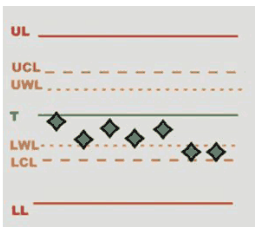

**Tool usability:** Tool can be used.

**Diagnosis:** Averages are lower than the Lower Warning Limit, but they do not fall under the lower tolerance limit.

**Further actions:** Calibrate increasing the torque.

• Last 4 averages out of 1/3 of the control limits

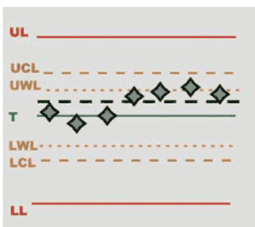

**Tool usability:** Tool can be used.

**Diagnosis:** Averages are higher than 1/3 of the Upper Control Limit, but they do not exceed the upper tolerance limit.

**Further actions:** Calibrate decreasing the torque.

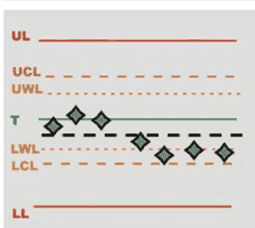

**Tool usability:** Tool can be used.

**Diagnosis:** Averages are below 1/3 of the Lower Control Limit, but they do not fall under the lower tolerance limit.

**Further actions:** Calibrate increasing the torque.

**Cm/Cmk test**

The Cm/Cmk test assesses the capability of a tool in terms of tool's repeatability and accuracy in operations. The test analyzes the tool's collected results in relation to a tolerance range defined by an upper limit and a lower limit.

The test assessment is based on two indexes:

- The **Cm** index describes the tool's capability meant as the number of times the spread of the tool's results values fits into the tolerance range. This means the Cm index describes how close the values of the collected results are to one another, determining the repeatability of the tool without taking into account how these values are positioned in relation to the upper and lower tolerance limits.
- The **Cmk** index describes the tool's capability corrected by the position of the results values within the tolerance range. This means the Cmk index expresses how close the collected results are to the target result value (the middle of the tolerance range) determining the accuracy of the tool in addition to the repeatability.

The higher the Cm/Cmk values, the better the tool's repeatability and accuracy.

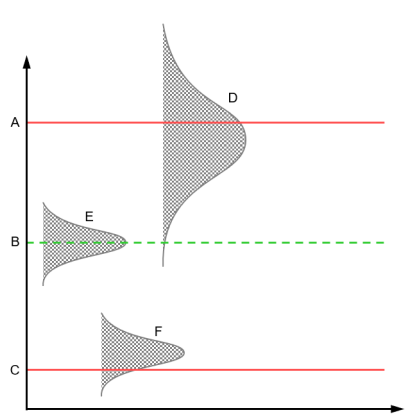

A	Upper tolerance limit	D	Cm: Low / Cmk: Low
B	Target value	E	Cm: High / Cmk: High
C	Lower tolerance limit	F	Cm: High / Cmk: Low

When the Cm is high, the tool is suitable for the assigned operation (if the Cmk is low, that means that the tool needs to be calibrated). On the other side, when the Cm is low the tool is not suitable for the assigned operation; in this case the tool must be repaired or, if a higher Cm value cannot be reached, it must be assigned to an operation with a wider tolerance range.

**Statistics types**

**CNOMO standard's formulas**

**Instantaneous standard deviation:  $\sigma_i$**

Estimated from the mean range ( $\overline{W}$ ) of the samples of 5 measurements which form the population:

$$\sigma_i = \frac{\overline{W}}{d5}$$

Where:

$$\overline{W} = \frac{\sum W}{K}$$

$W$  Range of measurements on each sample = max value - min value.

$K$  Number of samples of 5 measurements.

## Operation

$d_5$  Coefficient for a 95% confidence threshold

$$d_5 = 2.326 - \frac{1.645 \times 0.864}{\sqrt{K}}$$

**Instantaneous dispersion:  $D_i$**

$$D_i = 6 \times \sigma_i$$

**Process capability: CAM**

$$CAM = \frac{IT}{D_i}$$

Where

$IT$  Tolerance Interval = max tolerance - min tolerance.

**Testing the homogeneity of the population**

Each sample of measurements  $W$  must comply with:

$$\bar{W} < 0.643 \times \frac{IT}{CAMcdc}$$

**Standard deviation:  $\sigma$**

$$\sigma = \sqrt{\frac{\sum_{i=1}^N (x_i - \bar{x})^2}{N-1}}$$

Where the population mean ( $\bar{x}$ ) is:

$$\bar{x} = \frac{\sum_{i=1}^N x_i}{N}$$

$X_i$  Population value.

$N$  Number of measurements of the population.

**Corrected overall standard deviation:  $\sigma_0$**

$$\sigma_0 = C \times \sigma$$

Where  $C$  is a function of the number of samples collected:

Number of samples	Coefficient $C$
3	1.51
4	1.41
5	1.34
6	1.28
7	1.26

Number of samples	Coefficient C
8	1.24
9	1.22
10	1.21
11	1.19
12	1.18
13	1.17
14	1.17
15	1.16
16	1.15
17	1.15
18	1.14
19	1.14
20 to 22	1.13
23 to 25	1.12
26 to 31	1.11
32 to 35	1.10
36 to 44	1.09
45 to 51	1.08

**Coefficient of position and dispersion: Cpk**

$$C_{pk} = \min \left[ \frac{Tol_{max} - \bar{X}}{3\sigma_0}, \frac{\bar{X} - Tol_{min}}{3\sigma_0} \right]$$

The station is “capable” if the CAM is higher than the specified CAM.

The setting is correct if the Cpk is higher than the specified Cpk.

**ISO standard's formulas**

**Standard deviation:  $\sigma$**

$$\sigma = \sqrt{\frac{\sum_{i=1}^N (x_i - \bar{x})^2}{N-1}}$$

Where the population mean ( $\bar{x}$ ) is:

$$\bar{x} = \frac{\sum_{i=1}^N x_i}{N}$$

$X_i$  Population value.

$N$  number of measurements of the population.

**Process Capability: Cp**

$$Cp = \frac{IT}{6\sigma}$$

Where

## Operation

---

$IT$  Tolerance Interval = max tolerance - min tolerance.

$\sigma$  Standard deviation

**Coefficient of position and dispersion:  $C_{pk}$**

$$C_{pk} = \min \left[ \frac{Tol_{\max} - \bar{X}}{3\sigma}, \frac{\bar{X} - Tol_{\min}}{3\sigma} \right]$$

## Service

### Diagnostic

#### How to run a diagnostic

**i** To perform the following operation, the WRT battery charge level must be above 15%.

1. On the Web User Interface **Navigation menu**, select **Diagnostic**.
2. In the left panel of the **Diagnostic** page, click **Launch Diagnostic**.

**i** The diagnostic procedure must be performed until the end without turning off the device.

Some checks are performed automatically, while other require an input from the user. Follow the instructions provided by the dialogs on the Web User Interface:

Check	Description
Data memory	Performed automatically
Configuration memory	Performed automatically
Battery	Performed automatically
Gyroscope	Performed automatically
Rotor	Apply torque to the transducer to make sure the torque value is properly read. If the rotor is working, press <b>OK</b> ; if not, press <b>NOT OK</b> .
LEDs	Verify all LEDs light on as indicated in the dialog. If all LEDs are working, press <b>OK</b> ; if not, press <b>NOT OK</b> .
Keyboard	When prompted, press the keyboard button within 10 seconds.
WLAN	Performed automatically
RTC	Verify the date/time value displayed in the dialog is correct. If the date/time is correct, press <b>OK</b> ; if not, press <b>NOT OK</b> .
File system	Performed automatically
Angle encoder	Rotate the transducer to make sure the angle value is properly read. If the angle encoder is working, press <b>OK</b> ; if not, press <b>NOT OK</b> .
NFC	Performed automatically
Backup battery	Performed automatically

3. Once all checks have been performed, press **OK** at the bottom of the **Diagnostic** dialog.

If the date/time value resulted Not OK, a dialog opens to set the correct date and time for the diagnostic report. In the dialog, click **Calendar**  to select date and time.

The diagnostic report is available in the right panel of the **Diagnostic** page.

- ❗ The WRT can store up to 10 diagnostic reports. If there are already 10 stored diagnostic reports and a new diagnostic is run, the oldest report is automatically deleted to be replaced by the new diagnostic report.

To navigate the stored reports, use the numbered list at the top of the **Diagnostic** page's right panel. Reports are sorted from newest to oldest.

In the left panel of the **Diagnostic** page, the **Last Diagnostic Result** category displays *Status* and *Date* of the last diagnostic performed:

- If *Status* is **OK**, everything is working properly.
- If *Status* is **Not OK**, the diagnostic procedure detected at least one issue.

### How to download a diagnostic report



1. On the Web User Interface **Navigation menu**, select **Diagnostic**.
2. On top of the **Diagnostic** page right panel, navigate the numbered list to select the diagnostic report of interest.
3. In the upper-right corner of the page, click **Download** .
4. Save the diagnostic report locally as .pdf file.

### How to print a diagnostic report

1. On the Web User Interface **Navigation menu**, select **Diagnostic**.
2. On top of the **Diagnostic** page right panel, navigate the numbered list to select the diagnostic report of interest.
3. In the upper-right corner of the page, click **Print** .
4. In the print dialog, select the printer to use and configure the settings as applicable. Then, click **Print**.

### How to check alarms status

1. On the Web User Interface **Navigation menu**, select **Diagnostic**.
2. In the left panel of the **Diagnostic** page, next to **Alarms status**, click **Show** to open the **Alarms** window.

If the device has detected an issue, the relevant item is marked with the Not OK icon . Items that are working correctly are marked with the OK icon .

3. Click **OK** to close the **Alarms** window.

## Maintenance

- ❗ Actions and features described in this section might require permissions assigned only to specific user roles. For more information, refer to *User roles and permissions [Page 15]*.

### How to save results locally

1. On the Web User Interface **Navigation menu**, select **Maintenance**.
2. In the left panel of the **Maintenance** page, in the **Save Operation** category, look for the item **Save results**.  
To save results limited to a specific time range, click the switch next to **Date filter** to enable the feature.  
In the fields **From date** and **To date**, click **Calendar**  and select respectively a start and an end date in the date pickers.
3. Next to **Save results**, click **Save**.

### How to delete all tool and operations stored in the device

1. On the Web User Interface **Navigation menu**, select **Maintenance**.
2. In the left panel of the **Maintenance** page, in the **Memory operation** category, look for the item **Delete all tools and operations**.
3. Next to **Delete all tools and operations**, click **Delete**.
4. In the `confirmation` dialog, click **Yes** to confirm the operation.

### How to delete all curves and results stored in the device

1. On the Web User Interface **Navigation menu**, select **Maintenance**.

2. In the left panel of the **Maintenance** page, in the **Memory operation** category, look for the item **Delete all curves and results**.
  3. Next to **Delete all curves and results**, click **Delete**.
  4. In the `confirmation dialog`, click **Yes** to confirm the operation.
- i** The number reported in square brackets after **Delete all curves and results** is the number of curves and results currently stored in the device.

### How to reset the device to factory settings

1. On the Web User Interface **Navigation menu**, select **Maintenance**.
  2. In the left panel of the **Maintenance** page, in the **Memory operation** category, look for the item **Reset to factory settings**.
  3. Next to **Reset to factory settings**, click **Proceed**.
  4. In the `confirmation dialog`, click **Yes** to confirm the operation.
- i** When resetting the device to factory settings, **calibration values are the only data preserved**.
- i** After resetting the WRT to factory settings, connect the device to the computer via USB cable to configure the network parameters anew.

### How to enable/disable the Ethernet over USB connection

1. On the Web User Interface **Navigation menu**, select **Maintenance**.
  2. In the left panel of the **Maintenance** page, in the **USB operation** category, look for the item **Disable Ethernet over USB**.
  3. Next to **Disable Ethernet over USB**, click the switch to disable or enable the feature.
- i** By default the Ethernet over USB connection is enabled.

### How to enable/disable the Web User Interface Virtual Assistant

1. On the Web User Interface **Navigation menu**, select **Maintenance**.
2. In the left panel of the **Maintenance** page, in the **Assistant** category, look for the item **Show assistant**.
3. Next to **Show assistant**, click the switch to enable or disable the feature.

### How to enable/disable Log Files

1. On the Web User Interface **Navigation menu**, select **Maintenance**.
2. In the right panel of the **Maintenance** page, click the switch next to **Log file** to enable or disable the feature.

### How to select Log levels

1. On the Web User Interface **Navigation menu**, select **Maintenance**.
  2. In the right panel of the **Maintenance** page, click the switch next to **Log file** to enable the feature.
  3. In the **Level** drop-down list, select a Log level to filter the category of entries to show:
    - **Trace**
    - **Debug**
    - **Info**
    - **Warning**
    - **Error**
    - **Fatal**
- i** During normal operations, it is not recommended to select the **Trace** and **Debug** Log levels due to the very large log files these levels generate.

### How to download Log files

1. On the Web User Interface **Navigation menu**, select **Maintenance**.

2. In the right panel of the **Maintenance** page, click the switch next to **Log file** to enable the feature.
3. In the **Level** drop-down list, select the Log level of interest.  
For more information, refer to *How to select Log levels [Page 69]*.
4. In the upper-right corner of the **Maintenance** page's right panel, click **Download** .
5. Save the Logs locally as .txt file.

### How to print Log Files

1. On the Web User Interface **Navigation menu**, select **Maintenance**.
2. In the right panel of the **Maintenance** page, click the switch next to **Log file** to enable the feature.
3. In the **Level** drop-down list, select the Log level of interest.  
For more information, refer to *How to select Log levels [Page 69]*.
4. In the upper-right corner of the **Maintenance** page's right panel, click the **Print** .
5. In the print dialog, select the printer to use and configure the settings as applicable. Then, click **Print**.

### How to refresh Log file data

1. On the Web User Interface **Navigation menu**, select **Maintenance**.
2. In the right panel of the **Maintenance** page, click the switch next to **Log file** to enable the feature.
3. In the upper-right corner of the **Maintenance** page's right panel, click **Refresh** .

### How to delete Log Files

1. On the Web User Interface **Navigation menu**, select **Maintenance**.
2. In the right panel of the **Maintenance** page, click the switch next to **Log file** to enable the feature.
3. In the **Level** drop-down list, select the Log level to delete.  
For more information, refer to *How to select Log levels [Page 69]*.
4. In the upper-right corner of the **Maintenance** page's right panel, click **Delete** .
5. In the confirmation dialog, click **Yes** to confirm the operation.

## Maintenance Instructions

### Preventing ESD Problems

The components inside the product and controller are sensitive to electrostatic discharge. To avoid future malfunction, make sure that service and maintenance is carried out in an ESD approved work environment. The figure below shows an example of an appropriate service workstation.

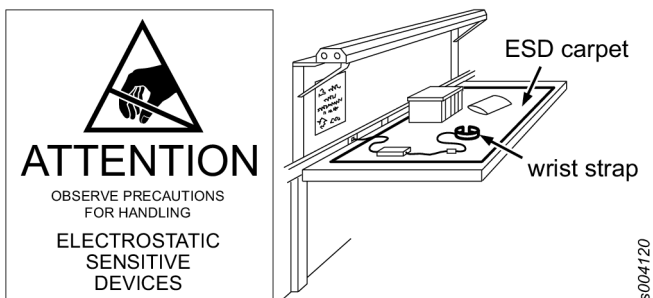

### Preventive Maintenance

#### Calibration

The WRT - Wireless Rotary Transducer must be calibrated at least once a year. Contact Desoutter Service for calibration.

#### Cleaning

Keep the WRT - Wireless Rotary Transducer clean.

After use, remove any traces of oil and grease from the WRT - Wireless Rotary Transducer with a soft cloth and a soft surface cleaner for oil/grease. Do not use aggressive or abrasive cleaner.

Use an anti-static cleaning cloth in order to remove dust from the WRT - Wireless Rotary Transducer.

Avoid using harsh detergents to clean the WRT - Wireless Rotary Transducer.

Clean the contact of the WRT - Wireless Rotary Transducer by using an electrical contact cleaner solution.

## Recycling

### Environmental Regulations

When a product has served its purpose it has to be recycled properly. Dismantle the product and recycle the components in accordance with local legislation.

Batteries shall be taken care of by your national battery recovery organization.

### Recycling information

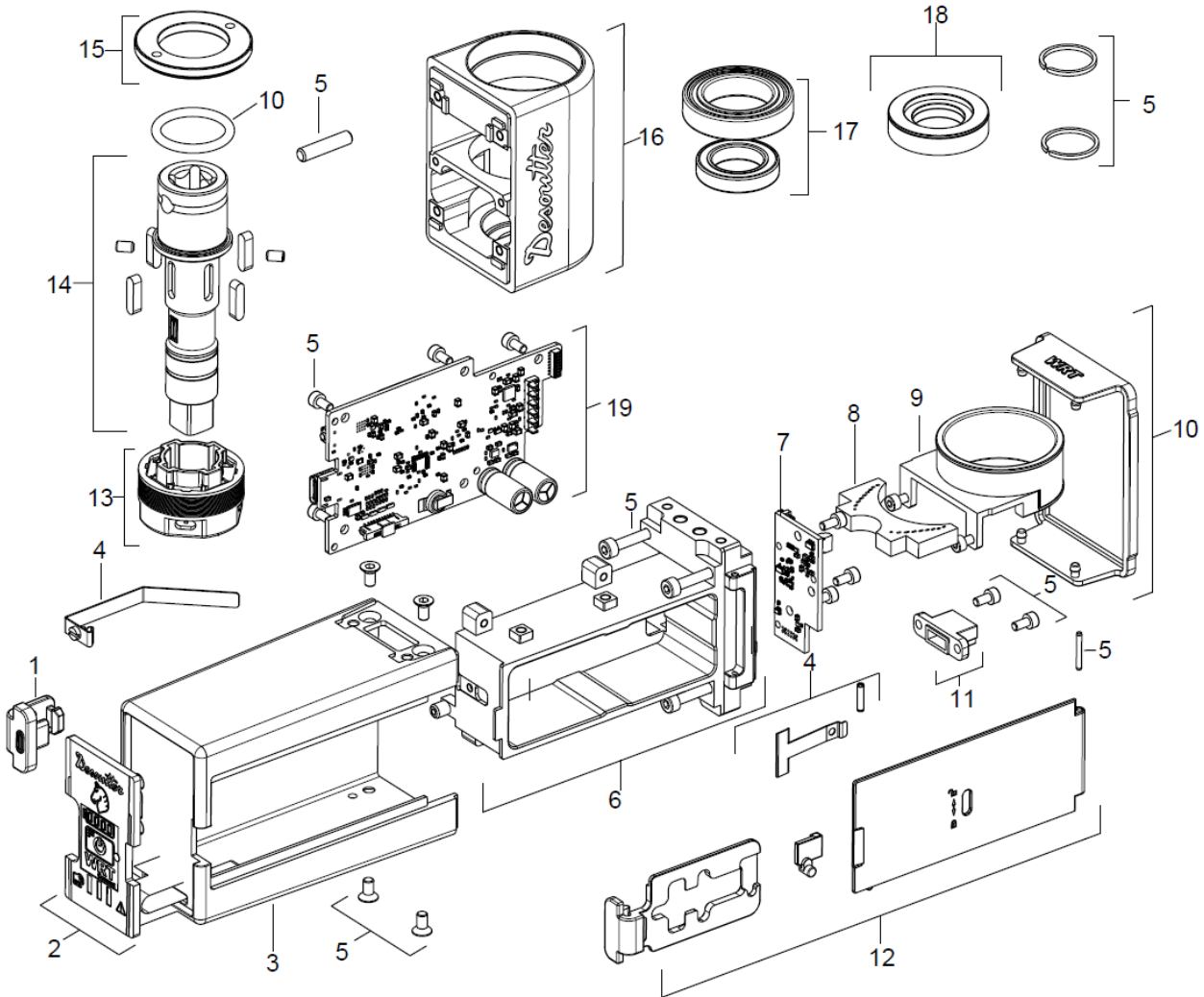

	Part	Recycle as
1	Cover board	Rubber
2	Keyboard	WEEE
3	Cover	Thermoplastic
4	Spring	Steel
5	Screw, Pin, Seeger	Steel
6	Battery housing	Aluminum
7	Sensing PCB	WEEE
8	Guidelight	Polycarbonate
9	Stator Coil	Not recyclable
10	Gasket	Rubber
11	Angle Sensor	WEEE
12	Locking Door	Aluminum
13	Rotor Board	Not recyclable
14	Transducer	Steel

---

	<b>Part</b>	<b>Recycle as</b>
15	Ringnut	Aluminum
16	Body	Aluminum
17	Bearing	Steel
18	Magnetic Ring	Steel
19	Main PCB	WEEE

---





Original instructions

Founded in 1914 and headquartered in France, Desoutter Industrial Tools is a global leader in electric and pneumatic assembly tools serving a wide range of assembly and manufacturing operations, including Aerospace, Automotive, Light and Heavy Vehicles, Off-Road, General Industry.

Desoutter offers a comprehensive range of Solutions -tools, service and projects- to meet the specific demands of local and global customers in over 170 countries.

The company designs, develops and delivers innovative quality industrial tool solutions, including Air and Electric Screwdrivers, Advanced Assembly Tools, Advanced Drilling Units, Air Motors and Torque Measurement Systems.

Find more on [www.desouttertools.com](http://www.desouttertools.com)



**More Than Productivity**